

250+ Productos



TARÍFA DE PRECIOS

2025/26



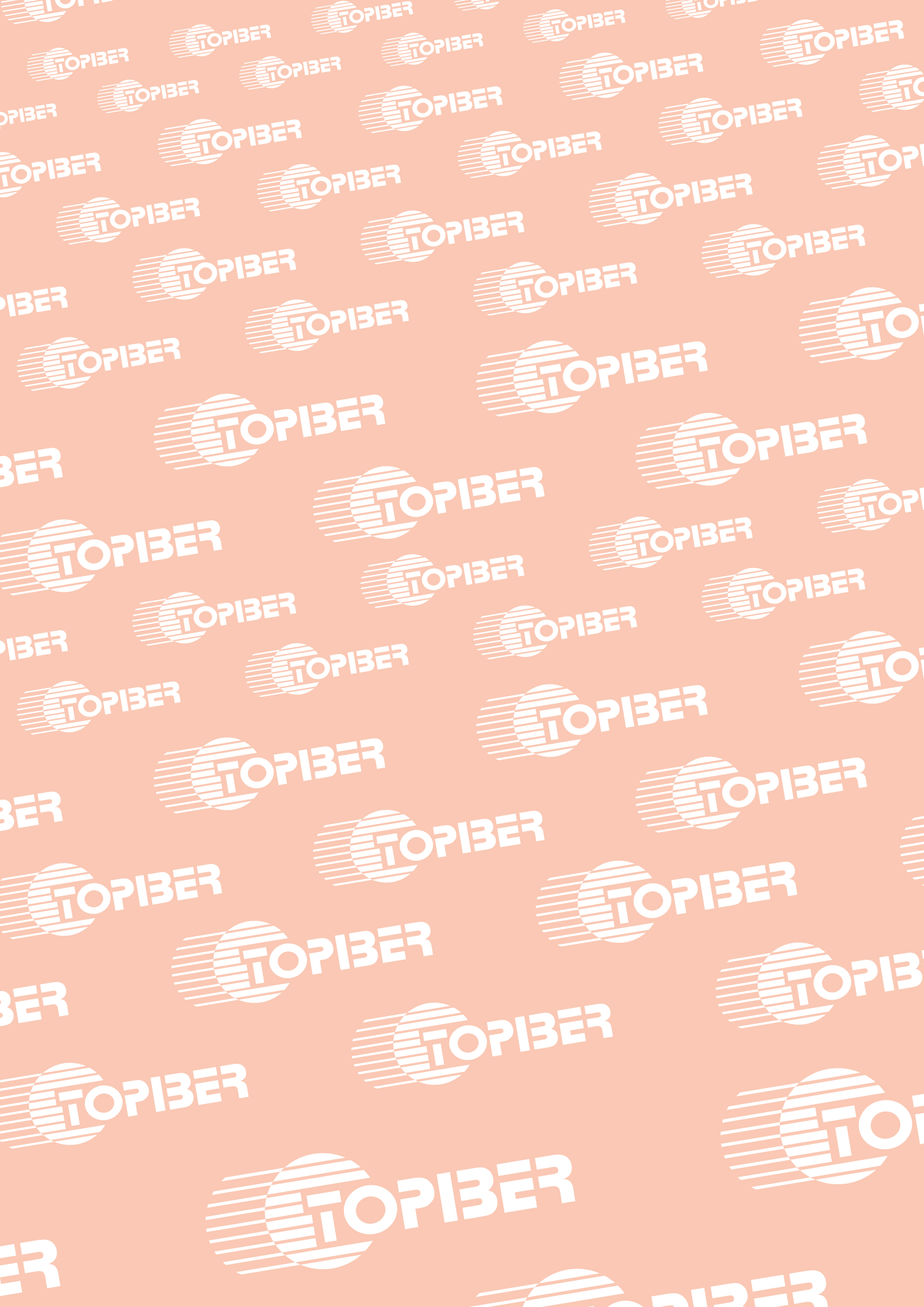



PVP y DESCUENTOS

Los precios de venta al público (PVP) de esta tarifa serán la base sobre la que se calcule el precio de venta a distribuidor (PVD) y entrarán en vigor desde el momento en el que la tarifa o cualquier modificación de la misma se publique en la página web de Topiber (www.topiber.com/tarifas-gama-topiber). En caso de discrepancia entre la tarifa física y la tarifa accesible en la página web, prevalecerá esta última.

Las condiciones de descuentos base y diferenciales se fijarán en función de las campañas negociadas para cada cliente con su delegado comercial de zona de Topiber.

CONDICIONES DE PAGO

Primera compra a la apertura de cuenta	Transferencia bancaria
Importe hasta 500€	Transferencia o giro bancario a 30 días
Importe entre 500€ y 2.000€	Transferencia o giro bancario a 30/60 días
Importe superior a 2.000€	Transferencia o giro bancario a 30/60/90 días
Descuento por pronto pago¹	1,5%

¹Excluyendo primeras compras a la apertura de cuenta

Rogamos verifique su forma de pago actual para evitar posibles errores.

En aplicación de la Ley 7/2012 de normas tributarias y materias para la prevención y lucha contra el fraude, no se aceptarán pagos en efectivo a partir del importe legalmente establecido.

En caso de que su medio de pago con nosotros sea giro bancario, le recordamos que debemos disponer de la autorización de domiciliación de adeudo SEPA.

FACTURACIÓN

En aplicación de la Ley 15/2010, Topiber, podrá agrupar varios pedidos mediante una factura resumen periódica, por un periodo nunca superior a 15 días. Bajo ningún concepto se excluirán del cómputo del plazo de pago los periodos considerados vacacionales.

En nuestro afán de proteger el medioambiente, Topiber realiza su facturación mediante factura electrónica con idéntica validez legal que la factura tradicional. Si prefiere recibir sus facturas en formato papel, puede comunicarlo en la siguiente dirección de correo electrónico: info@topiber.com

IMPAGADOS

El incumplimiento de los plazos de pago previstos dejará de inmediato sin validez todo compromiso adquirido desde Topiber (ej. descuentos, incentivos por compra, colaboraciones publicitarias, etc.)

La existencia de un impagado bloqueará inmediatamente la cuenta del cliente y significará la cancelación total del crédito. No se aplicará el descuento de pronto pago si existe un saldo pendiente a favor de Topiber y se repercutirá el coste financiero derivado de estos retrasos. En caso de impago, Topiber repercutirá al cliente todos los gastos asociados al mismo (gastos de devolución, financiación e intereses).

La disponibilidad de la mercancía no supone la propiedad de la misma. El cliente actúa como depositario hasta su pago total, quedando obligado a las disposiciones establecidas en el Art. 1766 del Código Civil.

CONDICIONES DE ENVÍO

Los costes de transporte en el envío de pedidos se regirán según las siguientes tablas:

España peninsular

Importe pedido	Portes aplicables	Excepciones
hasta 500€	100%	N/A
a partir de 500€	Exento	Remolques ensamblados, desbrozadoras de tractor

En caso de recepción de mercancía dañada en el transporte, el cliente deberá comunicar el incidente a Topiber en las 24h siguientes a la recepción del envío, incluyendo, copia del albarán de recepción donde se haya hecho constar la incidencia y una foto de la mercancía dañada. De no ser así, Topiber no puede garantizar la cobertura por daños de transporte.

DEVOLUCIONES DE MERCANCÍA

Sólo se pueden aceptar devoluciones de mercancía en el plazo de 15 días desde la fecha de recepción del producto. Cualquier devolución deberá ser tramitada a través de su delegado comercial, con quien el cliente ha de ponerse en contacto para obtener autorización de devolución. No se aceptará ninguna devolución que no disponga de dicha autorización, junto con el correspondiente albarán de venta.

Además de la autorización de devolución, para su aceptación y abono, la mercancía deberá estar en perfecto estado y con su embalaje original sin manipular. Salvo en casos de errores atribuibles a Topiber, los costes derivados de la devolución (transporte, gastos de cobro y bancarios, etc.) serán a cargo del cliente.

No será posible aceptar devoluciones que incumplan estas condiciones.

ENVASES, EMBALAJES Y GESTIÓN DE SUS RESIDUOS

En referencia a la normativa aplicable, se informa que la responsabilidad de la entrega de los residuos de envases y embalajes para su correcta gestión ambiental, recae en el poseedor final de los mismos.

STOPBER





Motosierras

P.04



Desbrozadores

P.07



Productos de Batería

P.16



Cuidado del Jardín

P.18



Cortacéspedes

P.20



Biotrituradores

P.26



Astilladoras y Sierras circulares

P.32



Molinos para grano

P.37



Fumigación

P.38



Hidrobombas

P.41



Motoazadas y Motocultores

P.42



Transporte

P.46



Motores, Motobombas y Generadores

P.48



Desbrozadoras de tractor

P.50



Pastores Electricos

P.54



Vareadoras de oliva

P.55



Accesorios y Recambios

P.56

Motosierra FANTON

F2500

Potencia	1.23 cv	Carburador	WALBRO
Peso	3.9 kg	Longitud de barra	25 cm
Cilindrada	25.4 c.c.	Engrase de cadena	Automático
Cadena	3/8" BP 0,050		

Motosierra de poda con motor de gasolina 2 tiempos

PVP s/IVA **175€**

PVP c/IVA **212€**



F3800

Motosierra FANTON

Potencia	1.77 cv	Carburador	WALBRO
Peso	5.6 kg	Longitud de barra	40 cm
Cilindrada	37,2 c.c	Engrase de cadena	Automático
Cadena	3/8" BP 0,050		

Motosierra con motor de gasolina 2 tiempos

PVP s/IVA **175€**

PVP c/IVA **212€**



Motosierra FANTON

F4600

Potencia	2.75 cv	Carburador	WALBRO
Peso	7 kg	Longitud de barra	45 cm
Cilindrada	46 c.c.	Engrase de cadena	Automático
Cadena	0,325" 0,058		

Motosierra con motor de gasolina 2 tiempos

PVP s/IVA **180€**

PVP c/IVA **218€**



F5200

Motosierra FANTON

Potencia	3 cv	Carburador	WALBRO
Peso	7.1 kg	Longitud de barra	45 cm
Cilindrada	52 c.c.	Engrase de cadena	Automático
Cadena	0,325" 0,058		

Motor de gasolina de 2 tiempos y **descompresor**

PVP s/IVA **195€**

PVP c/IVA **236€**



Motosierra FANTON

F5800

Potencia	3.2 cv	Carburador	WALBRO
Peso	7.2 kg	Longitud de barra	45 cm
Cilindrada	55 c.c.	Engrase de cadena	Automático
Cadena	0,325" 0,058		

Motosierra con motor de gasolina 2 tiempos

PVP s/IVA **210€**

PVP c/IVA **254€**



CABALLETE



PVP s/IVA **70€**

PVP c/IVA **85€**

MOTOSIERRAS GASOLINA





Motosierra FANTON

REC2200

Motor eléctrico	eléctrico 230 V	Longitud de corte	395 mm
Potencia	2200 W	Velocidad cadena	15,5 m/s
Longitud de espada	445 mm	Peso	4.6 kg
Cadena	3/8" BP 0,050	Engrase cadena	autom. c/visor nivel
Freno cadena	eléctrico		

PVP s/IVA **110€**
PVP c/IVA **133€**



RLC20TS

Motosierra FANTON

Batería de LITIO:	21 v / 4 Ah	Capacidad dep. Aceite:	120 ml
Tiempo de carga:	2 horas	Velocidad cadena:	7.5 m/seg con regulador
Barra:	10" (25,4 cm)	Peso:	2.9 kg c/batería
Freno de cadena:	Sí	Tensor de cadena:	sí
Engrase:	Automático		

SIN ESCOBILLAS

PVP s/IVA **196€**
PVP c/IVA **237€**

Incluye 1 batería y cargador



Motosierra FANTON

RLC40HD

Batería de LITIO:	40 V (2 x 20V) / 4 Ah	Capacidad dep. aceite:	220 ml
Tiempo de carga:	1 - 1.5 horas	Velocidad cadena:	15 m/seg. (con reg.)
Barra:	14" (35.5 cm)	Peso:	5 kg c/baterías
Freno de cadena:	Sí	Cadena:	3/8" BP 0,050
Engrase:	Automático		

PVP s/IVA **295€**
PVP c/IVA **375€**

Incluye 2 baterías y cargador



SIN ESCOBILLAS

RLC20HS

Motosierra FANTON

Batería de LITIO:	21 V / 2 Ah (2 bat)	Capacidad dep. aceite:	100 ml
Tiempo de carga:	1.5 - 2 horas	Velocidad cadena:	7.5 m / segundo
Barra:	6" (25 cm)	Peso:	1.3 kg c/batería
Engrase:	Automático	Tensor de cadena:	si

SIN ESCOBILLAS

PVP s/IVA **165€**
PVP c/IVA **200€**

Incluye 2 baterías y cargador



Motosierra FANTON

Prolongación telescópica

Adaptable a:	RLC20HS y RLP20
Longitud:	1,5 m

PVP s/IVA **45€**
PVP c/IVA **54€**

LONGITUD 1,5 m



MOTOSIERRAS ELÉCTRICAS BATERÍA



AS260-W

Motor	FANTON de 25,4 cc
Potencia,	1.0 CV
Manillar	doble
Barra	24 mm
Peso	6,3 kg

PVP s/IVA	260€
PVP c/IVA	315€

AS260-S

Motor	FANTON de 25,4 cc
Potencia	1.0 cv
Manillar	asa
Barra	24 mm
Peso	6,3 kg

PVP s/IVA	250€
PVP c/IVA	302€

Desbrozadores de barra ASUKA

Barra amortiguada	28 mm
Manillar	doble
Correaje	profesional
Motor	MEIKI TLE48N (Mitsubishi)
Cilindrada	47,1 c.c.
Potencia	2,45 cv
Peso	7,6 Kg

PVP s/IVA	480€
PVP c/IVA	623€

WS450 - TLE48

WS450 - TJ45

Barra amortiguada	28 mm
Manillar	doble
Correaje	profesional
Motor	KAWASAKI TJ45E
Peso	7,2 Kg

PVP s/IVA	480€
PVP c/IVA	581€

Desbrozadores de barra ASUKA
Desbrozadores de barra ASUKA

Barra amortiguada	28 mm
Manillar	doble
Correaje	profesional
Motor	KAWASAKI TJ53E
Cilindrada	53 c.c.
Potencia	2,7 cv
Peso	7,8 Kg

PVP s/IVA	520€
PVP c/IVA	629€

WS450 - TJ53

DESBROZADORES ASUKA



VF500 - TLE48

Desbrozadores de barra ASUKA



Barra profesional	amortiguada de 28 mm	Cilindrada	47,1 c.c.
Manillar	doble	Potencia	2,45 cv
Correaje	profesional.		
Motor	MEIKE TLE48N (Mitsubishi)		
Peso	8,9 Kg		

PVP s/IVA	555€
PVP c/IVA	657€

Desbrozadores de barra ASUKA

VF500 - TJ45

Barra profesional	Amortiguada 28mm
Manillar	doble
Correaje	Profesional
Motor	KAWASAKI TJ45E
Cilindrada	45,4c.c.
Potencia	1,9 cv
Peso	8,5 Kg



PVP s/IVA	560€
PVP c/IVA	678€

VF500 - TJ53

Desbrozadores de barra ASUKA



Barra profesional	Amortiguada de 28 mm	Cilindrada	53 c.c.
Manillar	doble	Potencia	1,9 cv
Correaje	profesional		
Motor	KAWASAKI mod. TJ53		
Peso	9,1 Kg		

PVP s/IVA	605€
PVP c/IVA	732€

Desbrozadores de mochila ASUKA

TLE48 FLEX

Barra profesional	Amortiguada 26 mm	Cilindrada	45,4 c.c.
Manillar	asa	Potencia	2,45 CV
Correaje	Mochila		
Motor	MEIKI TLE48N (Mitsubishi)		
Peso	12,4 Kg		

PVP s/IVA	650€
PVP c/IVA	787€

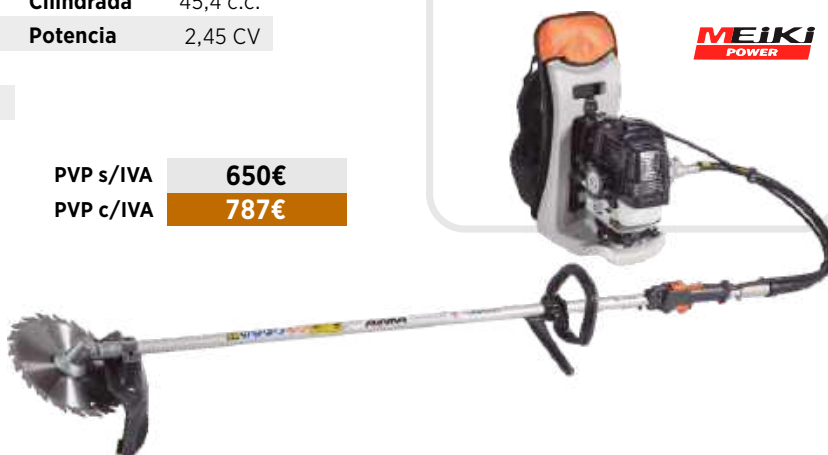

DESBROZADORES ASUKA

Desbrozadores de barra HOSHI

H260-S

Motor	FANTON de 25,4 c.c.	Barra	26 mm
Potencia	1,0 CV	Peso	6,1 kg
Manillar	de asa		

PVP s/IVA **198€**

PVP c/IVA **239€**



H48W

Desbrozadores de barra HOSHI

Motor	MEIKI mod. TLE48 (Mitsubishi)	Cilindrada	47,1 c.c	
Barra	de 28 mm		Potencia	2,45 CV
Manillar	doble regulable			
Accesorios	nylon y de 3 puntas, correa			
Peso	8.5 kg			

PVP s/IVA **430€**

PVP c/IVA **532€**



Desbrozadores de barra HOSHI

H45W

Motor	KAWASAKI mod. TJ45E	Cilindrada	45,4 c.c
Barra	28 mm	Potencia	1,9 CV
Manillar	doble regulable		
Accesorios	nylon y de 3 puntas, correa		
Peso	8,4 kg		

PVP s/IVA **440€**

PVP c/IVA **532€**



H53W

Desbrozadores de barra HOSHI

Motor	KAWASAKI mod. TJ53E	Cilindrada	53 c.c
Barra	28 mm	Potencia	2,7 CV
Manillar	doble regulable		
Accesorios	nylon y de 3 puntas, correa		
Peso	8,6 Kg		

PVP s/IVA **480€**

PVP c/IVA **581€**



DESBROZADORES HOSHI





Desbrozadores de barra FANTON

Motor de 2 tiempos	25,4 cc
Potencia	1,0 CV
Manillar	de asa
Barra	26 mm
Peso	6,3 kg

PVP s/IVA **151€**
PVP c/IVA **183€**

CG260-S



CG260-Y

Desbrozadores de barra FANTON

Motor de 2 tiempos	25,4 cc
Potencia	1,0 cv
Manillar	doble
Barra	26 mm
Peso	6,5 kg

PVP s/IVA **165€**
PVP c/IVA **200€**

Desbrozadores de barra FANTON

Motor de 2 tiempos	42,7 cc
Potencia	1,71 CV
Manillar	doble
Barra	28 mm
Peso	7,9 kg

PVP s/IVA **185€**
PVP c/IVA **224€**

CG430



CG520-Y

Desbrozadores de barra FANTON

Motor de 2 tiempos	51,6 cc
Potencia	2 CV
Manillar	doble
Barra	28 mm
Peso	8,1 kg

PVP s/IVA **198€**
PVP c/IVA **240€**

Desbrozadores de barra FANTON

Motor de 2 tiempos	50,8 cc
Potencia	2,3 CV
Manillar	doble
Barra	carenada y amortiguada de 28 mm
Peso	9.9 kg

PVP s/IVA **230€**
PVP c/IVA **278€**

BC508



DESBROZADORES FANTON

Multifunción FANTON

Motor + barra multifunción + barra desbrozador.

Motor	gasolina 2 tiempos
Cilindrada	25,4 cc
Potencia	1 CV
Manillar	con asa
Barra	26 mm / partida

PVP s/IVA	185€
PVP c/IVA	224€

Herramientas **MOTOSIERRA**

PVP s/IVA	79€
PVP c/IVA	96€

Herramientas **CORTASETOS**

PVP s/IVA	79€
PVP c/IVA	96€

PROLONGACIÓN de 80cm

PVP s/IVA	34€
PVP c/IVA	41€

BC360D



GZJ260N

Podadora de altura fija FANTON

Podadora de altura fija

Longitud	2,60 m
Motor	2 tiempos 25,4 cc
Potencia	1 cv
Peso	7,5 Kg

PVP s/IVA	236€
PVP c/IVA	286€



Podadora telescópica FANTON

Podadora de altura telescópica

Longitud máx.	hasta 4,10 m
Motor	2 tiempos 25,4 cc
Potencia	1 CV
Peso	9,5 Kg

PVP s/IVA	340€
PVP c/IVA	411€

GZJ260AE



AG52H

Ahoyador FANTON

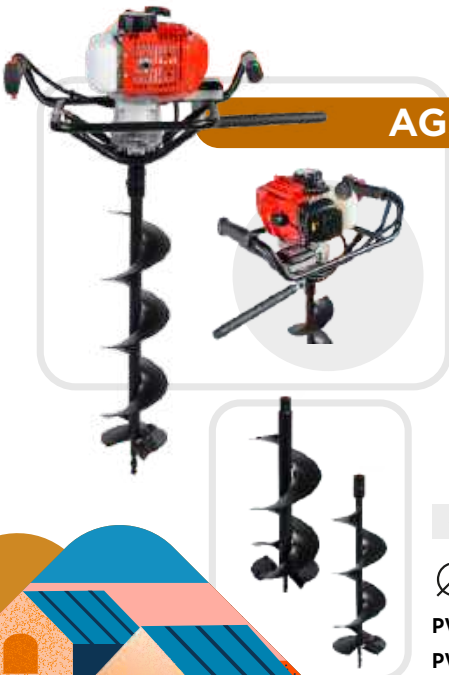

AHOYADOR

Motor de 2 tiempos: 52 cc

Potencia: 2 CV

Mecanismo de seguridad electrónico

Barrena de ø150mm (AG52H-150)

PVP s/IVA	260€
PVP c/IVA	315€

Barrena de ø200 mm (AG52H-200)

PVP s/IVA	270€
PVP c/IVA	327€



Opcionalmente se pueden adquirir barrenas de otras medidas

∅ de 100 mm

PVP s/IVA	50€
PVP c/IVA	61€

∅ de 150 mm

PVP s/IVA	60€
PVP c/IVA	73€

∅ de 200 mm

PVP s/IVA	70€
PVP c/IVA	85€

∅ de 250 mm

PVP s/IVA	80€
PVP c/IVA	97€



30

FM45

Motor	Gasolina de 4 tiempos
Cilindrada	170 c.c.
Potencia	5 CV
Embrague de cuchilla	Sí
Tipo de transmisión	Correa
Desplazamiento	manual
Grosor máx. hilo	4 mm
Peso	23 Kg

PVP s/IVA **365€**
PVP c/IVA **442€**



30

GMT60

Motor	Gasolina 4T 223 c.c. 6.5 CV
Ancho de corte	600 mm
Altura corte	30 - 120 mm
Caja de cambios	3 velocidades (2 adelante + 1 atrás)
Regulación de manillar	en altura y lateralmente
Elementos de triturado	32 cuchillas Y de acero
Peso	135 kg

PVP s/IVA **1.950€**
PVP c/IVA **2.360€**



40

HM52

Motor	Gasolina 2 tiempos
Cilindrada	51.8 cc
Potencia	2 CV (1.5 Kw)
Barra	28mm
Peso	10,1 kg
Incluye	Cabezal Nylon (aluminio) y disco de wídea 36 puntas

PVP s/IVA **245€**
PVP c/IVA **296€**



30

FM55

Motor	de 4 tiempos
Cilindrada	170,1 cc
Potencia	5,0 CV
Embrague de cuchilla	Sí
Tipo de transmisión	Correa
Desplazamiento	autopropulsado
Grosor máx. hilo:	4 mm
Peso:	53 Kg

PVP s/IVA **820€**
PVP c/IVA **992€**



DESBROZADORES FANTON

RLC48RL

RL210H

RL2006B

RL115RL

RECATO Gator

**CON DIFERENCIAL
CON FRENO**

MODELO	RLC48RL	RL2006B	RL210H	RL115RL	RECATO Gator
Motor	RV170S	Briggs Stratton	Honda GCV200	RV225 OHV	Honda GX390
Cilindrada	173 cc (4 t)	163 cc (4 t)	201 cc (4 t)	233 cc (4 t)	390 cc (4 t)
Velocidades	1 Adelante	1 Adelante	7 adel. + 1 atrás	7 adel. + 1 atrás	7 adel.+ 1 atrás
Reglaje de altura	Sí (5 - 9,5cm)	Sí (5 - 11 cm)	Sí (5 - 11 cm)	Sí (5 - 11 cm)	Sí (5 - 11 cm)
Salida	Lateral	Lateral	Lateral	Trasera	Trasera
Ancho de trabajo	48 cm	53 cm	53 cm	53 cm	60 cm
Superficie aconsejada	1.500 m.	2.500 m.	4.000 m.	4.000 m.	6.000 m.
Peso	43 Kg	60 Kg	90 Kg	90 Kg	140 Kg
PVP s/IVA	872€	1.150€	1.995€	1.850€	3.325€
PVP c/IVA	1.055€	1.392€	2.414€	2.238€	4.023€

**DESBROZADORES
ROQUES LECOEUR**



PREDATOR-84

NUEVO / NOVEDAD



HIDROSTÁTICO

Motor	RV550 OHV c/ arranque eléctrico
Cilindrada	547 cc
Potencia	17 CV
Transmisión	Hidrostática Hydro Gear T3
Velocidad	Adelante 0-6.7 km/h Atrás 0-3.4 km/h
Ancho de trabajo	84 cm
Regulación de altura	Sí (43-101 mm)
Salida	Trasera
Freno de cuchilla	Sí, con parada < 5 s
Embrague de cuchilla	Electromagnético
Dimensiones	Largo 1.830 mm Ancho 880 mm Alto 1.000 mm
Peso	230 kg



PVP s/IVA **5.175€**
PVP c/IVA **6.262€**

**DESBROZADORES
ROQUES LECOEUR**



MGM Lampacrescia

Motor	HONDA GX160
Ancho corte	60 cm
Altura corte	20-80 mm
Velocidades	2 Adelante + 1 Atrás
Frenos	De disco
Ruedas	13x 500-6
Peso	115 kg

TTR580

PVP s/IVA	3.175€
PVP c/IVA	3.842€

TTR790

Motor	HONDA GX270
Ancho corte	75 cm
Altura corte	20-80mm
Velocidades	2 Adelante + 1 Atrás
Frenos	De disco
Ruedas	16x 650-8
Peso	155kg

MGM Lampacrescia

PVP s/IVA	4.750€
PVP c/IVA	5.748€

MGM Lampacrescia

Motor	HONDA GX270
Ancho corte	75 cm
Altura corte	20-80 mm
Velocidades	2 Adelante + 1 Atrás
Frenos	De disco
Ruedas	16x 650-8
Peso	185 kg

PVP s/IVA	5.435€
PVP c/IVA	6.576€

TTR783

Desbloqueo independiente de ruedas



Desbloqueo independiente de ruedas

TTR886

Motor	HONDA GX390
Ancho corte	87 cm
Altura corte	20-80 mm
Velocidades	4 Adelante + 2 Atrás
Frenos	De disco
Ruedas	16x 650-8
Peso	210 kg

MGM Lampacrescia

PVP s/IVA	6.500€
PVP c/IVA	7.865€

MGM Lampacrescia

Motor	HONDA GX390
Ancho corte	87 cm
Altura corte	20-80 mm
Velocidades	4 Adelante + 2 Atrás
Frenos	De disco
Ruedas	Con orugas
Peso	285 kg



Desbloqueo independiente de oruga

TTR886HD

PVP s/IVA	7.535€
PVP c/IVA	9.117€



STOPIBER



Tijeras de poda FANTON
RLP16

Batería de LITIO	16.8V/2.0Ah (incl. 2 bat.)		
Tiempo de carga	1 - 1.5 horas		
Diámetro máx. corte	27 mm		
Reg. apertura de cuchilla	Sí, 3 posiciones		
Tiempo estimado trabajo	3 - 4 horas	PVP s/IVA	172€
Peso	900 gramos	PVP c/IVA	208€

Incluye 2 baterías y cargador



2X

RLP20
Tijeras de poda FANTON

Batería de LITIO	21V / 2.5 Ah.		
Tiempo de carga	2 horas	PVP s/IVA	215€
Diámetro máx. corte	35 mm	PVP c/IVA	260€
Reg. de apertura de cuchilla	Sí, 2 posic.		
Tiempo estimado trabajo	4 horas		
Pantalla con información	Sí		
Peso	1.050 gramos		

Incluye 1 batería y cargador

Motosierras FANTON
RLC20HS

Batería de LITIO	21 V / 2 Ah (2 bat)	Capacidad dep. aceite	100 cc
Tiempo de carga	1.5 - 2 horas	Velocidad cadena	7.5 m / segundo
Barra	6" (25 cm)	Peso	1.3 kg c/batería
Engrase	Automático	Tensor de cadena	Sí

PVP s/IVA	165€
PVP c/IVA	200€

Incluye 2 baterías y cargador

SIN ESCOBILLAS



2X

RLC20TS
Motosierras FANTON

Batería de LITIO	21 v / 4 Ah	Capacidad dep. Aceite	120 ml
Tiempo de carga	2 horas	Velocidad cadena	7.5 m/seg con regulador
Barra	10" (25,4 cm)	Tensor de cadena	Sí
Freno de cadena	Sí	Peso	2.9 kg c/batería
Engrase	Automático		

PVP s/IVA	196€
PVP c/IVA	237€

Incluye 1 batería y cargador

SIN ESCOBILLAS

Motosierras FANTON
RLC40HD

Batería de LITIO	40 V (2 x 20 V) / 4 Ah	Capacidad dep. aceite	220 ml
Tiempo de carga	1 - 1.5 horas	Velocidad cadena	15 m/seg. (con reg.)
Barra	14" (35.5 cm)	Cadena	3/8" BP 0,050
Freno de cadena	Sí	Peso	5 kg c/baterías
Engrase	Automático		

PVP s/IVA	295€
PVP c/IVA	375€

Incluye 2 baterías y cargador

SIN ESCOBILLAS

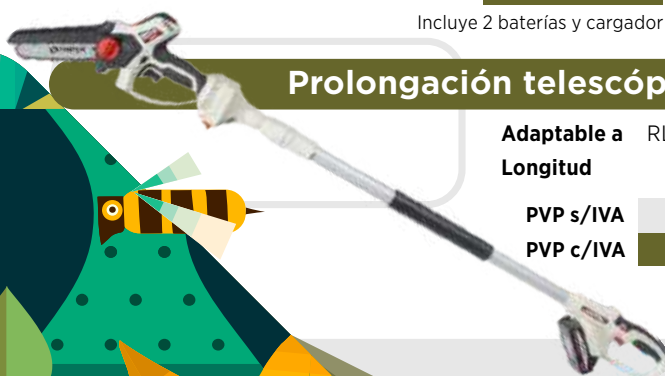
Prolongación telescópica
Motosierras FANTON

Adaptable a	RLC20HS y RLP20
Longitud	1,5 m

PVP s/IVA	45€
PVP c/IVA	54€

PRODUCTOS DE BATERÍA



RLMT40DR Desbrozador multifunción FANTON



Ahora con barra de extensión incluida

Batería	2 x 20 V/4.0 Ah Li-ion
Motor	eléctrico 40V sin escobillas (BRUSHLESS)
Duración de batería	1.5-2.0 h según uso
Funciones	Desbrozador (nylon y disco acero) Cortasetos, L=390 mm c/ sable orientable Motosierra de poda, Long. corte = 260 mm Barra de extensión L=80 cm (todo incluido en el precio)

PVP s/IVA **370€**

PVP c/IVA **448€**

Incluye 2 baterías y cargador

Cortasetos de batería FANTON

Batería	2 x 20 V/4.0 Ah Li-ion
Motor	eléctrico 40 V
Longitud de corte	650 mm
Grueso máximo	30 mm
Peso	3.8 kg
Funciones	Doble filo. Posición de corte orientable 180°

PVP s/IVA **298€**

PVP c/IVA **361€**

Incluye 2 baterías y cargador

RLHT40D



RLB20SF



Cortabordes de batería FANTON

Batería	20 V/4.0 Ah Li-ion
Motor	eléctrico 20 V sin escobillas (BRUSHLESS)
Duración de batería	45-60 min. según uso
Ø de corte	300 mm
Peso	2.4 kg
Funciones	Barra telescópica con asa orientable Cabezal orientable 90° con rueda guía para muros

PVP s/IVA **165€**

PVP c/IVA **200€**

Incluye 1 batería y cargador

Baterías FANTON

Batería 21 V, 2 Ah

PVP s/IVA **39€**

PVP c/IVA **47€**



Batería 21 V, 4 Ah

PVP s/IVA **62€**

PVP c/IVA **75€**



PRODUCTOS DE BATERÍA TOPIBER

Soplador - Aspirador FANTON

BV260BN

Motor	Gasolina 2T
Cilindrada	25.4 c.c.
Potencia	0.75 kW (1 CV)
Bolsa recogedora	incluida
Caudal de aire	0,17 m ³ /s
Peso	4.3 kg

PVP s/IVA **185€**
PVP c/IVA **224€**



EB700

Soplador FANTON



Motor	Gasolina 2T
Cilindrada	65 c.c.
Potencia	3.8 CV (2.8 kW) a 3060 rpm
Caudal de aire	0,32 m ³ /s
Peso	10 kg

PVP s/IVA **255€**
PVP c/IVA **309€**

Soplador FANTON

EB900

Motor	Gasolina 2T
Cilindrada	82.4 cc
Potencia	5.44 cv
Caudal de aire	0,42 m ³ /s
Arranque	fácil
Peso	9 kg

PVP s/IVA **310€**
PVP c/IVA **375€**

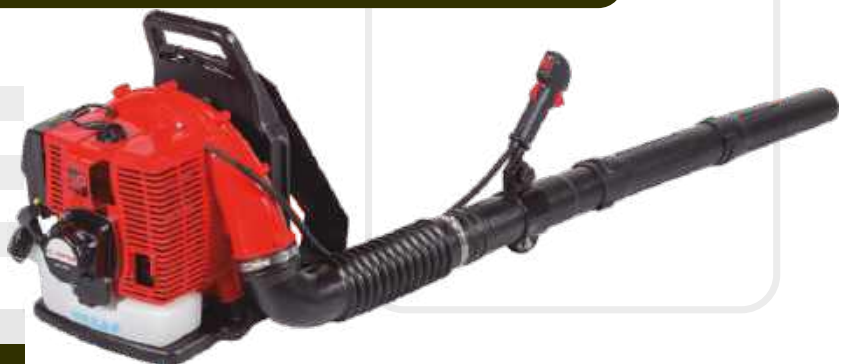



Cortasetos eléctrico KINGARDEN

HTEG37-660

Motor	Eléctrico
Potencia	700 W
Longitud barra de corte	610 mm
Grosor máx de corte	24 mm
Posiciones de trabajo	giratoria 0°-90°

PVP s/IVA	92€
PVP c/IVA	111€



HT55

Cortasetos gasolina KINGARDEN

Motor	Gasolina 2T
Desplazamiento	26 c.c.
Longitud barra de corte	550 mm
Grosor máx de corte	28 mm
Posiciones de trabajo	giratoria 0°-90°
Peso	5.9 kg

PVP s/IVA	175€
PVP c/IVA	212€



Cortasetos gasolina KINGARDEN

TJ23V

Motor	Gasolina 2T KAWASAKI TJ23
Desplazamiento	23 c.c.
Longitud barra de corte	600 mm
Grosor máx de corte	28 mm
Posiciones de trabajo	giratoria 0°-90°
Peso	5.6 kg

PVP s/IVA	420€
PVP c/IVA	508€



RLHT40D

Cortasetos batería FANTON

Motor	Eléctrico 40V
Batería	Li-ion 2 x 20 V / 4.0 Ah
Tiempo de carga	2h, Cargador doble
Ajuste de posición	3 ángulos de trabajo (horizontal, 2 verticales)
Longitud de corte	65 cm
Espaciado de dientes	30 mm
Tipo de sable	doble filo
Peso	3.8 kg

PVP s/IVA	298€
PVP c/IVA	361€





Modelo	RM600	RM1200
Área máxima	600 m ²	1.200 m ²
Altura de corte	20-60 mm	20-60 mm
Ancho de corte	18 cm	18 cm
Batería	Ion Litio 20V 2.5Ah	Ion Litio 20V 5.0Ah
Tiempo de carga	2.2 h	1.6 h
Autonomía	2-2.5 h	3-3.5 h
Interfaz de control	Teclado & display LED en robot Aplicación móvil IOS & Android	Teclado & display LED en robot Aplicación móvil IOS & Android
Pendiente máxima de trabajo	20° (35%)	20° (35%)
Función multizona	Sí - 4 puntos de inicio de trabajo	Sí - 4 puntos de inicio de trabajo
Actualización firmware	Sí, automática a través de aplicación móvil	Sí, automática a través de aplicación móvil
Parada de emergencia	Sí (botón de parada y sensor de inclinación)	Sí (botón de parada y sensor de inclinación)
Sensor de lluvia	Sí, con programación de espera	Sí, con programación de espera
Accesorios incluidos	130 m de cable perimetral 180 piquetas de cable 6 piquetas base de carga 6 cuchillas de corte de repuesto 6 tornillos fijación de cuchilla	180 m de cable perimetral 250 piquetas de cable 6 piquetas base de carga 6 cuchillas de corte de repuesto 6 tornillos fijación de cuchilla
Accesorios opcionales	Capota para base de carga (ver foto)	Capota para base de carga (ver foto)



PVP s/IVA **630€**
PVP c/IVA **762€**



PVP s/IVA **865€**
PVP c/IVA **1.047€**

Capota con base de carga (opcional)

PVP s/IVA **85€**
PVP c/IVA **103€**





FRA46Q

Cortacésped FANTON

Motor	Gasolina 4 tiempos
Cilindrada	144 c.c.
Chasis	acero
Ajuste altura de corte	centralizado (25mm-75mm)
Ancho de corte	46 cm
Configuraciones	mulching, salida lateral, recogida trasera
Desplazamiento	Autopropulsado
Recogedor	60 L
Indicador de llenado	Sí
Peso	33.5 kg

PVP s/IVA **325€**

PVP c/IVA **393€**



KINGGARDEN

CORTACÉSPEDES

Cortacésped eléctrico KINGGARDEN

Motor	eléctrico de 1.400 vatios
Chasis	polímero ABS
Ancho de corte	38 cm
Ajuste altura	centralizado (25-75mm)
Desplazamiento	empujado
Configuraciones	recogida trasera
Peso	13 Kg

PVP s/IVA **145€**

PVP c/IVA **175€**

DYM115E

RODAMIENTOS EN RUEDAS



DYM1181E

RODAMIENTOS EN RUEDAS



PVP s/IVA **187€**

PVP c/IVA **226€**

Cortacésped eléctrico KINGGARDEN

Motor	eléctrico de 1.800 vatios
Chasis	acero
Ancho de corte	46 cm
Eleva ruedas	centralizado (25-75 mm)
Desplazamiento	empujado
Configuraciones	recogida trasera
Peso	24,1 Kg

Cortacésped gasolina KINGGARDEN

DYM1676C-3

Motor	gasolina 4 tiempos con 135 cc
Chasis	acero
Ancho de corte	46 cm
Ajuste altura	centralizado (25-75 mm)
desplazamiento	autopropulsado
Configuraciones	recogida trasera, salida lateral, mulching
Peso	35,6 Kg

PVP s/IVA **375€**

PVP c/IVA **454€**

AUTO PROPULSADO



Cortacésped KINGGARDEN
DYM1678-D3

Motor	gasolina 4 tiempos con 173 c.c.
Arranque	manual / eléctrico
Chasis	acero
Ancho de corte	51 cm
Ajuste altura	centralizado (25-75 mm)
desplazamiento	autopropulsado
Configuraciones	recogida trasera, salida lateral, mulching
Peso	39,5 Kg

ARRANQUE ELÉCTRICO

PVP s/IVA	425€
PVP c/IVA	514€

DYM162601
Cortacésped KINGGARDEN

Motor	4 tiempos con 173cc
Chasis	acero
Ancho de corte	51 cm
Ajuste de altura	centralizado (25-75 mm)
Desplazamiento	autopropulsado
Configuraciones	recogida trasera, salida lateral, mulching
Peso	31,7 Kg

MULCHING

PVP s/IVA	410€
PVP c/IVA	496€

Cortacésped KINGGARDEN
DYM1688-3

Motor	4 tiempos con 173cc
Chasis	aluminio
Ancho de corte	51 cm
Ajuste de altura	centralizado (25-75 mm)
Desplazamiento	autopropulsado
Configuraciones	recogida trasera, salida lateral, mulching
Peso	40,5 Kg

PVP s/IVA	510€
PVP c/IVA	617€

**CORTACÉSPEDES
KINGGARDEN**



Cortacésped gasolina **MARINA**

Motor	Kohler XT7.75 OHV
Cilindrada	173 cc
Chasis	aluminio
Ancho de Corte	51 cm
Recogedor	70 L
Configuraciones	recogida trasera
Desplazamiento	autopropulsado
Ajuste de altura	centralizado (20-70 mm)
Peso	37 Kg

GX51SK

PVP s/IVA	780€
PVP c/IVA	944€



GX51SH

Cortacésped gasolina **MARINA**

Motor	Honda GCV200
Cilindrada	201 cc
Chasis	aluminio
Ancho de Corte	51 cm
Recogedor	70 L
Configuraciones	recogida trasera
Desplazamiento	autopropulsado
Ajuste de altura	centralizado (20-70 mm)
Peso	38 Kg

PVP s/IVA	840€
PVP c/IVA	1.016€



Cortacésped **MARINA**

MX46SH

Motor	Honda GCV160
Cilindrada	166 cc
Chasis	acero inoxidable
Ancho de Corte	46 cm
Recogedor	70 L
Configuraciones	recogida trasera, salida lateral
Desplazamiento	autopropulsado
Ajuste de altura	centralizado (20-65 mm)
Peso	35 Kg

PVP s/IVA	780€
PVP c/IVA	944€



MX52SH

Cortacésped gasolina **KINGARDEN**

Motor	Honda GCV200
Cilindrada	201 cc
Chasis	acero inoxidable
Ancho de Corte	52 cm
Recogedor	70 L
Configuraciones	recogida trasera, salida lateral
Desplazamiento	autopropulsado
Ajuste de altura	centralizado (20-65 mm)
Peso	37 Kg

PVP s/IVA	895€
PVP c/IVA	1.083€



Cortacésped gasolina **KINGARDEN**

MX550SH

Motor	Honda GCV200
Cilindrada	201 cc
Chasis	acero inoxidable
Ancho de Corte	55 cm
Recogedor	70 L
Configuraciones	recogida trasera, salida lateral
Desplazamiento	autopropulsado
Ajuste de altura	centralizado (20-65 mm)
Peso	40 Kg

PVP s/IVA	965€
PVP c/IVA	1.168€



30



Cortacésped gasolina ASUKA LM5360 HTA-PRO
PROFESIONAL

Motor	HONDA GXV160
Potencia	6 CV
Cilindrada	163 c.c.
Par máximo	9.6 Nm a 2500 rpm
Chasis	aluminio (incl. ruedas)
Ajuste de altura	independiente 15 mm-77 mm en 7 posiciones
Desplazamiento	autopropulsado por cardan
Velocidad de avance	0.7 m/s marcha lenta 1.1 m/s marcha rápida
Ancho de corte	53 cm
Peso	56 kg
Configuraciones	descarga y recogida traseras (recogedor 75L), mulching (opcional)
Nivel de ruido	97 dB
Nivel de vibración	4.0 m/s2

PVP s/IVA	1.750€
PVP c/IVA	2.118€

KIT MUCHING

PVP s/IVA	155€
PVP c/IVA	188€

TRACTORES Y GIROS-CERO
PRÓXIMAMENTE

Tractores cortacésped
TRF86
TRF98

Ancho corte:	86 cm	98 cm
Motor:	Gasolina 4T	Gasolina 4T
Cilindrada:	432 c.c.	452 c.c.
Altura corte:	30-90 mm / 7 pasos	30-90 mm / 7 pasos
Transmisión:	Hidrostática c/ pedal	Hidrostática c/ pedal
Embrague cuchilla: E	Electromagnético	Electromagnético
Recogedor:	Trasero 240 L	Trasero 240 L
Corte hacia atrás:	Sí	Sí
	(con interruptor de seguridad)	(con interruptor de seguridad)
Nº cuchillas:	2 ud / 430 mm	2 ud / 490 mm
Faros frontales:	LED	LED
Peso:	188 Kg	200 Kg



30

PVP s/IVA	2.565€
PVP c/IVA	3.104€

PVP s/IVA	2.775€
PVP c/IVA	3.358€

KIT MULCHING

PVP s/IVA	110€
PVP c/IVA	133€

KIT MULCHING

PVP s/IVA	120€
PVP c/IVA	145€

ENGANCHE REMOLQUE

PVP s/IVA	75€
PVP c/IVA	91€





GIRO-CERO FANTON

GCF107



Ancho corte	107 cm
Motor	Gasolina 4T, bicilíndrico
Cilindrada	586 c.c.
Depósito combustible	11.5 L
Configuración	Salida lateral
Altura de corte	25-102 mm / 7 pasos
Transmisión	Hidrostática
Velocidad máx.	9 km/h adelante - 4 km/h atrás
Nº cuchillas	2 ud. L540 mm
Embrague cuchilla	Electromagnético
Peso	228 Kg

PVP s/IVA	4.695€
PVP c/IVA	5.681€

KIT MULCHING

PVP s/IVA	140€
PVP c/IVA	169€



**CORTACÉSPEDES
TOPIBER**



Serie HT Triturado en 2 fases: cuchillas + aspas



Biotrituradores Serie HT FANTON

Motor	gasolina 4 tiempos OHV
Encendido	Manual
Cilindrada	207 cc
Potencia	7 CV (3600 r.p.m.)
Velocidad rotor	2400 r.p.m.
Sistema de triturado	Volante c/cuchillas y aspas
Ø max. corte	60 mm
Peso	70 kg

HT-SC7



PVP s/IVA **875€**

PVP c/IVA **1.059€**

HT-SC15

ARRANQUE ELÉCTRICO



Biotrituradores Serie HT FANTON

Motor	4 tiempos OHV
Encendido	Eléctrico / Manual
Cilindrada	420 cc
Parada de emergencia	Sí
Potencia	15 CV (3600 r.p.m.)
Velocidad rotor	2400 r.p.m.
Sistema de triturado	Volante c/cuchillas y aspas
Ø max. corte	70 mm
Peso	110 kg

PVP s/IVA **1.295€**

PVP c/IVA **1.567€**

Serie BT Triturado en 1 etapa: tambor con cuchillas



Biotrituradores Serie BT FANTON

Motor	Eléctrico de INDUCCIÓN
Potencia	3.8 CV (2,8 Kw)
Sistema de triturado	Tambor c/cuchillas
Ø max. corte	30 mm
Diametro ruedas	300 mm
Parada de emergencia	Sí
Capacidad recogedor	65 litros
Peso	48 kg

EC50

CON SACO EXTRAIBLE



PVP s/IVA **498€**

PVP c/IVA **603€**

GC50

CON SACO EXTRAIBLE



PVP s/IVA **505€**

PVP c/IVA **611€**

Biotrituradores Serie BT FANTON

Motor	gasolina LONCÍN 4 tiempos OHV
Cilindrada	196 cc
Potencia	6.5 CV (3600 r.p.m.)
Sistema de triturado	Tambor c/cuchillas
Grosor máx. a triturar	50 mm
Diametro ruedas	300 mm
Parada de emergencia	Sí
Capacidad recogedor	65 litros
Peso	65 kg

BIOTRITURADORES
FANTON





Biotrituradores Serie BT FANTON

Motor	LONCIN 4T OHV
Cilindrada	196 c.c.
Potencia	6.5 CV
Sistema triturado	Tambor c/cuchillas
Grosor máx.	100 mm
Transmisión	2 correas Kevlar
Embrague tambor	centrífugo
Parada emergencia	Sí, 3 puntos
Peso	93 kg

PVP s/IVA **895€**
PVP c/IVA **1.083€**

GS650



GS1500



PVP s/IVA **1.495€**
PVP c/IVA **1.809€**

Biotrituradores Serie BT FANTON

Motor	LONCIN 4T OHV
Cilindrada	420 c.c.
Potencia	15 CV
Sistema triturado	Tambor c/cuchillas
Grosor máx.	120 mm
Transmisión	2 correas Kevlar
Embrague tambor	centrífugo
Parada emergencia	Sí, 3 puntos
Peso	194 kg

Biotrituradores Serie BT FANTON

Motor de BIOTRITURADOR	LONCIN 4 tiempos OHV
Cilindrada / Potencia	420 cc / 15 CV
Sistema de triturado	Tambor c/ cuchillas
Transmisión	2 Correas
Embrague	Centrífugo
Grosor máx. a triturar	120 mm
Motor TRANSPORTER	LONCIN 4 tiempos OHV
Cilindrada / Potencia	196cc / 6.5 CV
Velocidades	3 Adelante + 1 Atrás
Peso	325 Kg

PVP s/IVA **3.215€**
PVP c/IVA **3.890€**

TGS1500



!! INCLUYE CAJA EXTENSIBLE !!



BIOTRITURADORES
FANTON



Serie C-O Triturado en 2 etapas: cuchillas + martillos volantes
Biotrituradores C-O
SPRINT

Motor	Elect. monof. 250 V
Potencia/Cilindrada	3 cv (2-2 Kw)
Ø max. corte	35mm
Numero cuchillas corte	2
Numero martillos	6
Túnel de entrada	305x305 mm
Peso	60 kg

PVP s/IVA	1.095€
PVP c/IVA	1.325€

SPRINT GP
Biotrituradores C-O

Motor	HONDA GP160
Potencia/Cilindrada	4.8 CV / 163 cc
Ø max. corte	40 mm
Numero cuchillas corte	2
Numero martillos	6
Túnel de entrada	305x305 mm
Peso	70 kg

PVP s/IVA	1.350€
PVP c/IVA	1.634€

Biotrituradores C-O
TRITONE GX200

Motor	HONDA GP200
Potencia/Cilindrada	5.8 CV / 196 cc
Ø max. corte	60 mm
Numero cuchillas corte	2
Numero martillos	8
Túnel de entrada	360x360 mm
Peso	99 kg



PVP s/IVA	1.785€
PVP c/IVA	2.160€



(Rueda frontal opcional)

TRITONE TDF P
Biotrituradores C-O

Motor	TDF Tractor
Potencia Tractor	18 HP mínimo
Ø max. corte	70 mm
Numero cuchillas corte	2
Numero martillos	8
Túnel de entrada	360x360 mm
Peso	110 kg

PVP s/IVA	1.750€
PVP c/IVA	2.117€

Biotrituradores CECCATO OLINDO
TRITONE GX390

Motor	HONDA GX390
Potencia/Cilindrada	11.7 CV / 389 cc
Ø max. corte	70 mm
Numero cuchillas corte	2
Numero martillos	8
Túnel de entrada	650x420 mm
Peso	138 kg

PVP s/IVA	2.615€
PVP c/IVA	3.164€



Biotrituradores C-O
TRITONE TDF G

Motor	TDF Tractor
Potencia tractor	18HP mínimo
Ø max. corte	80 mm
Número cuchillas corte	2
Número martillos	8
Túnel de entrada	650x420 mm
Peso	120kg

PVP s/IVA	2.470€
PVP c/IVA	2.989€

MAXI SEMOVENTE
Biotrituradores C-O

Motor	HONDA GX390
Potencia / cilindrada	11.7 CV / 389 cc
Ø max. corte	70 mm
Cuchillas de corte	2
Cuchillas Triturar	8
Túnel de entrada	650x420 mm
Desplazamiento	Autopropulsado
Peso	157 kg

PVP s/IVA	3.275€
PVP c/IVA	3.963€

Biotrituradores C-O
BIG CINGO

Motor	HONDA GX390	Desplazamiento	con oruga
Potencia / cilindrada	11.7 CV / 389 cc	Capacidad de carga	850 Kg
Ø max. corte	80 mm	Motor transportes	HONDA GP160 (4.8 CV)
Cuchillas de corte	2	Velocidades	4 Vel. (3 adelante, 1 atrás)
Número martillos	10		
Túnel Entrada	650x420 mm		
Peso	380 kg		

PVP s/IVA	7.125€
PVP c/IVA	8.621€

CAJA EXTENSIBLE INCLUIDA

MONSTER 390
Biotrituradores C-O

Motor	HONDA GX390
Potencia / cilindrada	11.7 CV / 389 cc
Espesor max. de trabajo	100mm
Cuchillas de corte	4
Número martillos	24
Túnel Entrada	620x520 mm
Peso	350 kg

PVP s/IVA	4.720€
PVP c/IVA	5.711€

Biotrituradores C-O
MONSTER TDF

Motor	TDF Tractor
Potencia tractor	30 CV mín.
Espesor max. de trabajo	100mm
Cuchillas de corte	4
Cuchillas Triturar	24
Túnel Entrada	620x520 mm
Peso	353 kg

PVP s/IVA	4.835€
PVP c/IVA	5.850€



Biotrituradores C-O
SUPER MONSTER 390

Alimentación Motor	HONDA GX390
Potencia / cilindrada	11.7 CV / 389 cc
Ø max. de corte	120 mm
Cuchillas de corte	4
Cuchillas triturar	24
Túnel entrada	560x960 mm
Sistema alimentación	hidráulico No-Stress
Peso	501 kg

ALIMENTACIÓN HIDRÁULIDA
ANTI-STRESS

PVP s/IVA	8.975€
PVP c/IVA	10.860€

SUPER MONSTER TDF
Biotrituradores C-O

Motor	TDF Tractor
Potencia tractor	30 CV mín.
Ø max. corte	130 mm
Cuchillas de corte	4
Número martillos	24
Túnel entrada	560x960 mm
Sistema alimentación	hidráulico No-Stress
Peso	500 kg

PVP s/IVA	8.560€
PVP c/IVA	10.358€

ALIMENTACIÓN HIDRÁULIDA
ANTI-STRESS

Biotrituradores C-O
SUPER MONSTER 390R

c/Remolque homologado para via pública

Peso 700 kg

PVP s/IVA	10.468€
PVP c/IVA	12.666€

MEGA MOSTER C-O

MM 690
MM TDF
MM 690R*

Motor	HONDA GX690	N/A	HONDA Gx690
Potencia/Cilindrada	22.1 CV / 688 cc	Tractor 30-50 CV	22.1 CV / 688 cc
Ø max. corte	150 mm	150 mm	150 mm
Número cuchillas corte	2	2	2
Número martillos	24	24	24
Túnel de entrada	560x960 mm	560x960 mm	560x960 mm
Sistema alimentación	hidráulico No-Stress	hidráulico No-Stress	hidráulico No-Stress
Peso	600 kg	610 kg	710 kg

PVP s/IVA	14.855€	PVP s/IVA	14.855€	PVP s/IVA	16.240€
PVP c/IVA	17.975€	PVP c/IVA	17.975€	PVP c/IVA	19.650€

*con remolque homologado



STOPIBER



JT9T

 Astilladoras **FANTON**

Motor	eléctrico monofásico 230 V
Potencia	3.5 Kw
Fuerza de corte	10 t
Largo de corte	610, 800 y 1.060 mm
Posiciones de corte	vertical
Modo de corte	cuña móvil
Peso	120 Kg

PVP s/IVA **660€**
PVP c/IVA **798€**

 Astilladoras **FANTON** **TTE12T**

Motor	eléctrico monofásico 230 V
Potencia	3.5 Kw
Fuerza de corte	12 t
Posiciones de corte	3 (polivalente)
Modo de corte	cuña móvil
Peso	112 Kg

PVP s/IVA **890€**
PVP c/IVA **1.077€**

TTG15T

 Astilladoras **FANTON**

Motor	4 tiempos (gasolina)
Cilindrada	207 cc
Pot. motor	7 CV
Fuerza de corte	15 t.
Largo max. de corte	52 cm
Modo de corte	cuña móvil
Posiciones de corte	3 (Polivalente)
Peso	115 Kg

PVP s/IVA **975€**
PVP c/IVA **1.180€**

 Astilladoras **FANTON**
LS22T-650 POL

Motor	Gasolina 4t.
Potencia / Cilindrada	7 CV / 207 cc
Fuerza de corte	22 T
Modo de corte	cuña móvil
Largo max. de corte	65 cm
Posiciones de corte	2 (Polivalente)
Peso	147 Kg

PVP s/IVA **1.350€**
PVP c/IVA **1.634€**



(*) Remolque no apto para circular por vía pública

**ASTILLADORAS
FANTON**



LS35T-650 POL

Astilladoras **FANTON**

Motor	4 tiempos (gasolina)
Cilindrada	270cc
Potencia motor	9 HP
Fuerza de corte	35 t
Largo máx. de corte	65 cm
Posic. de corte	2 (Polivalente)
Remolque	Sí (*)

PVP s/IVA	1.965€
PVP c/IVA	2.378€



Astilladoras **FANTON** LS35T-650 POL R

Motor	4 tiempos (gasolina)
Potencia / cilindrada	9 CV / 270 cc
Fuerza de corte	35 t
Largo máx. de corte	650 mm
Posiciones de corte	2 (polivalente)
Modo de corte	cuña móvil
Remolque	Sí (homologado)
Peso	165 Kg (+175 Kg remolque)

PVP s/IVA	3.490€
PVP c/IVA	4.223€

c/remolque homologado para la vía pública



TTG35T-650H

Astilladoras **FANTON**

Motor	Gasolina 4 t
Cilindrada	270 cc
Potencia motor	9 CV
Fuerza de corte	35 t
Largo máx. de corte	65 cm
Posic. de corte	horizontal
Modo de corte	cuña fija
Remolque	Sí (*)

PVP s/IVA	2.400€
PVP c/IVA	2.904€

Eleva-troncos HIDRÁULICO

2ª CUÑA HORIZONTAL DE ALTURA AJUSTABLE HIDRÁULICAMENTE



Eleva-troncos HIDRÁULICO



ASTILLADORAS FANTON

(*) Remolque no apto para circular por vía pública

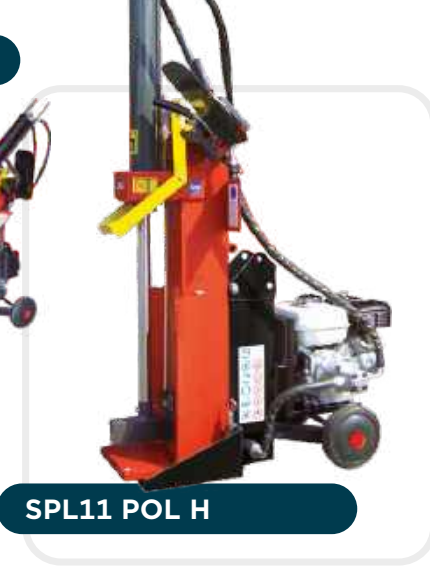
SPLE 10 POL

SPL11 POL H

SPLT11 POL

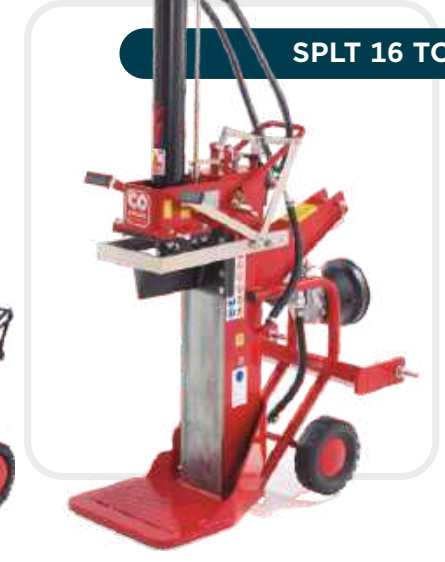
SPLE 11

SPLE 12

SPLT 16 TC

MODELO	SPLE 10 POL	SPL11 POL H	SPLT11 POL	SPLE 11	SPLE 12	SPLT 16 TC
Motor	Eléctrico monofásico	HONDA GX200	TDF Tractor	Eléctrico monofásico	Eléctrico monofásico	TDF Tractor
Potencia	2.2 Kw (3 CV)	5.8 CV	mín. 18 CV	2.2 Kw (3 CV)	2.2 Kw (3 CV)	mín. 18 CV
Fuerza	10 Tn	11 Tn.	11 Tn	10 Tn	12 Tn	16 Tn
Posic. trabajo	3 (Polivalente)	3 (Polivalente)	3 (Polivalente)	1 (Vertical)	1 (Vertical)	1 (Vertical)
Largo de corte	570mm	570mm	570mm	540mm	540mm	650mm
Bomba	Simple	Simple	Simple	Doble	Doble	Simple
Dimensiones	810x510x1680	810x510x1680	900x800x1680	800x540x1070	820x600x1070	1100x810x1840
Peso	120 Kg	135 Kg	152 Kg	111 Kg	144 Kg	255 Kg
PVP s/IVA	1.798€	2.065€	1.887€	1.710€	1.925€	2.318€
PVP c/IVA	2.176€	2.499€	2.283€	2.069€	2.329€	2.805€

ASTILLADORAS CECCATO OLINDO



Sierra circular CECCATO OLINDO

Motor	eléctrico monofásico 230 V
Potencia	2.2 Kw (3 CV)
Ø sierra	600 mm
Ø max. tronco	260 mm
Freno de cuchilla	Sí, en 10 s
Ø transmisión	2 correas
Palanca bloqueo tronco	Sí

PVP s/IVA **1.760€**
PVP c/IVA **2.130€**

SGT22E

SGT160

Motor	HONDA GP160
Cil./Potencia	163 cc / 4.8 CV
Ø sierra	600 mm
Ø max. tronco	260 mm
Freno de cuchilla	Sí, en 10 s
Ø transmisión	2 correas
Palanca bloqueo tronco	Sí

PVP s/IVA **1.820€**
PVP c/IVA **2.202€**

SGT200

Motor	HONDA Gp200
Cil. / Potencia	3 cc / 5.8 CV
Ø sierra	600 mm
Ø max. tronco	260 mm
Freno de cuchilla	Sí, en 10 s
Ø transmisión	2 correas
Palanca bloqueo tronco	Sí

PVP s/IVA **1.905€**
PVP c/IVA **2.305€**

SGT TDF
Sierra circular CECCATO OLINDO

Motor	TDF Tractor
Potencia tractor	18 CV mínimo
Ø sierra	600 mm
Ø max. tronco	260 mm
Freno de cuchilla	Sí, en 10 s
Ø transmisión	2 correas
Palanca bloqueo tronco	Sí

PVP s/IVA **1.820€**
PVP c/IVA **2.202€**

**SIERRAS
CECCATO OLINDO**

30

STOPIBER



PM3 Molino triturador

 Molinos **CECCATO OLINDO**

Motor	Eléctrico monofásico 230 V
Potencia	2.2 kW (3 CV)
Modo de triturado	9 cuchillas-martillo
Cribas	3 unidades (2, 4 y 8 mm)
Rendimientos	grano de maíz - 270 kg/h mazorca de maíz - 180 kg/h grano de trigo - 80 kg/h grano de cebada, avena o centeno - 80 kg/h
Peso	39 kg

PVP s/IVA	825€
PVP c/IVA	998€

MOLINOS
FANTON

 Molinos **FANTON**
FM20 Molino

Motor	Monofásico 230 V
Potencia	2 Kw
Longitud barra de corte	610 mm
Grosor máx de corte	24 mm
Posiciones de trabajo	giratoria 0°-90°
Cribas	2, 4, 8 mm

PVP s/IVA	175€
PVP c/IVA	202€

MOLINOS

Fumigadora de mochila FANTON
TF-800

Motor	gasolina 2T
Cilindrada	26 cc
Potencia	1 CV
Capacidad	25 litros
Bomba	latón de pistones
Aplicadores	pistola c/ regulador lanza c/ 3 boquillas

PVP s/IVA	210€
PVP c/IVA	254€

C100L 1R
Carretilla sulfatadora AGROSA

1 RUEDA
(incluye pistola) Manguera PVP s/IVA 1,50€

Motor	gasolina 4T OHV
Cilindrada	80 cc
Potencia	2.5 CV
Capacidad	100 litros
Bomba	25 atm de membrana
Caudal	20 l/min
Aplicadores	pistola c/ regulador (incluida)
Peso	35 kg

PVP s/IVA	625€
PVP c/IVA	756€

OPCIÓN MOTOR ELÉCTRICO

PVP s/IVA	985€
PVP c/IVA	1.192€

C100L 2R

Motor	gasolina 4T OHV
Cilindrada	80 cc
Potencia	2.5 CV
Capacidad	100 litros
Bomba	25 atm de membrana
Caudal	20 l/min
Aplicadores	pistola c/ regulador (incluida)
Peso	35 kg

PVP s/IVA	655€
PVP c/IVA	793€

OPCIÓN MOTOR ELÉCTRICO

PVP s/IVA	1.015€
PVP c/IVA	1.228€

Manguera PVP s/IVA 1,50€

(incluye pistola)
C50L 2R

Motor	gasolina 4T OHV
Cilindrada	80 cc
Potencia	2.5 CV
Capacidad	50 litros
Bomba	25 atm de membrana
Caudal	20 l/min
Aplicadores	pistola c/ regulador (incluida)
Peso	35 kg

PVP s/IVA	565€
PVP c/IVA	684€

Manguera PVP s/IVA 1,50€



Manguera

Manguera de carretilla (metro)

PVP s/IVA **1,50€**

PVP c/IVA **1,80€**



Enrollador 50m

con soporte para acoplar a carretilla

PVP s/IVA **120€**

PVP c/IVA **145€**

Grupo carretilla 20ATM

Motor gasolina 4T OHV

Cilindrada 80 cc

Potencia 2.5 CV

Bomba 25 atm de membrana

Caudal 20 l/min

Peso 16 kg



MOTOR

PVP s/IVA **145€**

PVP c/IVA **175€**

BOMBA

PVP s/IVA **195€**

PVP c/IVA **236€**

GRUPO COMPLETO

PVP s/IVA **320€**

PVP c/IVA **387€**



TF22-168

Motor gasolina 4T OHV

Cilindrada 197 cc

Bomba de 3 pistones

Caudal 22 l/min

Presión 40 atm

Aplicadores Pistola

c/ manguera 20 m

(incluidos)

PVP s/IVA **340€**

PVP c/IVA **411€**



FUMIGACIÓN

ETOPIBER





Hidrobomba eléctrica FANTON

LT503-1800

Motor	eléctrico monofásico
Potencia	1.800 W
Bomba	3 pistones
Presión máx.	140 bar
Caudal máx.	420 l/hora
Auto Stop	sí

PVP s/IVA	149€
PVP c/IVA	180€



LT703-2500

Hidrobomba eléctrica FANTON

Motor	eléctrico monofásico
Potencia	2.500 W
Bomba	3 pistones
Presión máx.	195 bar
Caudal máx.	470 l/hora
Lanza turbo	sí
Auto Stop	sí

PVP s/IVA	295€
PVP c/IVA	357€



Hidrobomba gasolina FANTON

SRPW3100

Motor	gasolina 4T
Cilindrada	212 cc
Potencia	7 CV
Bomba	Annovi Reverberi
Pistones	acero inox
Manguera	goma con refuerzo acero
Presión máx.	195 bar
Caudal máx.	9 l/min

PVP s/IVA	495€
PVP c/IVA	599€



SRPW4200

Hidrobomba gasolina FANTON

Motor	gasolina 4T
Cilindrada	420 cc
Potencia	14 CV
Bomba	Annovi Reverberi
Pistones	cerámicos
Manguera	goma con refuerzo acero
Presión máx.	270 bar
Caudal máx.	15 l/min

PVP s/IVA	975€
PVP c/IVA	1.180€



**HIDROBOMBAS
FANTON**

Motoazada FANTON

SR1Z-45Q

Motor	gasolina 4T
Cilindrada	150 cc
Caja de cambios	monomarcha
Ancho de trabajo	430 - 630 mm
Diámetro de fresa	250 mm
Peso	35 kg
Aperos incl.	rueda de traslado

PVP s/IVA	325€
PVP c/IVA	393€



Motoazada FANTON

SR1Z-75



PVP s/IVA	465€
PVP c/IVA	563€

Aperos incl.	rueda de traslado
	aporcador
	juego de fresas
	juego de ruedas 4.00 x 8

Motor	gasolina 4T
Cilindrada	212 cc
Potencia	7 CV
Caja de cambios	2 adelante + 1 atrás
Ancho de trabajo	620 - 820 mm
Diámetro de fresa	300 mm
Peso	76 Kg

Motoazada FANTON

SR1Z-80

Motor	gasolina 4T
Cilindrada	212 cc
Potencia	7 CV
Filtros aire	Filtro elevado en manillar Filtro c/ baño aceite en motor
Caja de cambios	3 adelante + 1 atrás
Ancho de trabajo	620 - 820 mm
Diámetro de fresa	350 mm
Peso	98 kg

PVP s/IVA	585€
PVP c/IVA	708€

Aperos incl.	rueda de traslado
	aporcador
	juego de fresas
	juego de ruedas 5.00 x 8



SR1Z-100

Motoazada FANTON



PVP s/IVA	635€
PVP c/IVA	768€

Aperos incl.	rueda de traslado
	aporcador
	juego de fresas
	juego de ruedas 4.00 x 8

Motor	gasolina 4T
Cilindrada	212 cc
Potencia	7 CV
Caja de cambios	2 adelante + 1 atrás
Ancho de trabajo	620 - 820 mm
Diámetro de fresa	350 mm
Peso	109 kg

REMOLQUE

Frenos	de pie y de estacionamiento
Suspensión	ballestas
Descarga	volquete

PVP s/IVA	640€
PVP c/IVA	774€



MOTOAZADAS
FANTON





Motocultor FANTON

RG60

Motor	gasolina 4T
Potencia	7 CV
Arranque	manual
Caja de cambios	2 adelante + 1 atrás
Ancho de fresa	500 - 700 mm
Ruedas	4.00 x 8
Peso	110 kg (incl. fresa)

PVP s/IVA	925€
PVP c/IVA	1.119€



ACE330

Motocultor FANTON



Motor	gasolina 4T
Potencia	7 CV
Arranque	manual
Caja de cambios	3 adelante + 2 atrás
Ancho de fresa	500 - 650 mm
Diámetro de fresa	280 mm
Ruedas	4.00 x 10
Peso	85 kg / fresa 40kg

PVP s/IVA	1.650€
PVP c/IVA	1.997€

Opción ACE330AE con arranque eléctrico

PVP s/IVA	1.775€
PVP c/IVA	2.148€

Motocultor FANTON

ACE330D AE

Motor	diésel
Potencia	8 CV
Arranque*	manual y arranque eléctrico
Caja de cambios	3 adelante + 2 atrás
Ancho de fresa	500 - 650 mm
Diámetro de fresa	280 mm
Ruedas	5.00 x 10
Peso	120 kg / fresa 40kg

PVP s/IVA	2.220€
PVP c/IVA	2.686€



MODELO	CARACTERISTICAS	PVP s/IVA	PVP c/IVA
AF-S120	Barra de siega de 1,20 m para ACE330 y ACE330D	620€	750€
TL65	Fresa de 65 cm para ACE330 y ACE330D	480€	580€

MOTOCULTORES FANTON



Motocultor MGM Lampacrescia

Motor	diésel
Potencia	8 CV
Arranque	manual y arranque eléctrico
Caja de cambios	3 adelante + 3 atrás
Embrague	multidisco en seco
Ancho de fresa	400 - 650 mm reducible a 400 mm
Ruedas	5.00 x 10 / desplazables
Peso	130 kg (incl. fresa)

Castoro 4308

Castoro 4308

PVP s/IVA	4.425€
PVP c/IVA	5.354€

Castoro 4308 AE*

PVP s/IVA	4.895€
PVP c/IVA	5.923€

con arranque eléctrico*

Castoro 4312

Motocultor MGM Lampacrescia

Motor	diésel
Potencia	12 CV
Arranque	manual y eléctrico
Caja de cambios	4 adelante + 3 atrás
Embrague	multidisco en seco
Ancho de fresa	500 - 800 mm reducible a 500 mm
Ruedas	6.50/80 x 12 / desplazables
Peso	150 kg (incl. fresa)

Castoro 4312

PVP s/IVA	4.730€
PVP c/IVA	5.723€

Castoro 4312 AE*

PVP s/IVA	5.125€
PVP c/IVA	6.201€

con arranque eléctrico*





APERO	Motocultor MGM	Motocultor FANTON	Motoazada FANTON	PVP s/IVA	PVP c/IVA
Fresa 50 cm Boxer	X			435,00 €	526,00 €
Fresa 60 cm Boxer	X			680,00 €	822,00 €
Fresa 60 cm /3+3	X			865,00 €	1.046,65 €
Fresa 65 cm Castoro 4308	X			950,00 €	1149,50 €
Fresa 80 cm 4312	X			1.030,00 €	1.246,30 €
Fresa 65 cm ACE		X		480,00 €	580,80 €
TR60 - Desbrozadora de martillos 60 cm	X	X		1.710,00 € +175€ +IVA adaptador para FANTON ACE330	2.069,10 €
TR80 - Desbrozadora de martillos 80 cm	X			1.925,00 €	2.329,25 €
Desbrozadora de cuchilla 60 cm	X	X		1.190,00 € +175€ +IVA adaptador para FANTON ACE330	1.439,90 €
Barra de siega 100 cm MGM	X			785,00 €	949,85 €
Barra de siega 127 cm MGM	X			1.190,00 €	1.439,90 €
Barra de siega 120 cm AF-S120		X		620,00 €	750,00 €
Rueda de transporte para fresa	X	X		45,00 €	54,45 €
Aporcador extensible	X	X	X	95,00 €	114,95 €
Arranca patatas	X	X	X	98,00 €	118,58 €
Arado de varillas con soporte	X	X	X	215,00 €	260,15 €
Arado semirrotativo	X	X	X	205,00 €	248,05 €
Kit de ruedas metálicas (hexagonal 23 mm)			X	125,00 €	151,25 €
Kit de ruedas neumáticas 4.00 x 8			X	90,00 €	108,90 €
Juego de mangones fijos (hexagonal 23 mm)			X	65,00 €	78,65 €
Juego de mangones desplazables (hexagonal 23 mm)			X	110,00 €	133,10 €
Kit de ruedas de transporte laterales			X	80,00 €	96,80 €
Kit de contrapesos para rueda 4.00 x 8.0/10			X	190,00 €	229,90 €
Kit de contrapesos para rueda 6.50 x 8.0/12	X	X		230,00 €	278,30 €



Carretilla eléctrica FANTON

EWD300A

Motor	eléctrico 40V
Batería	ión Litio 40V
Capacidad batería	6Ah
Volumen bañera	80 litros
Carga máxima	300 kg
Autonomía en distancia	20 km
Transmisión	directa
Freno	Sí (eléctrico)
Marcha atrás	Sí

PVP s/IVA **815€**
PVP c/IVA **986€**



FWD300B

Carretilla eléctrica FANTON

Motor	eléctrico 40V
Batería	ión Litio 40V
Capacidad batería	6Ah
Volumen bañera	100 litros
Carga máxima	300 kg
Autonomía en distancia	20 km
Transmisión	grupo con diferencial
Freno	Sí (eléctrico + mecánico)
Marcha atrás	Sí

PVP s/IVA **1.060€**
PVP c/IVA **1.283€**

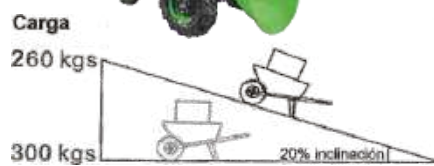

Caja Tubular Extensible

PVP s/IVA **150€**
PVP c/IVA **182€**

Batería lón-Li 40V 6Ah

PVP s/IVA **175€**
PVP c/IVA **212€**

Cargador 40V

PVP s/IVA **35€**
PVP c/IVA **42€**

Carretilla gasolina FANTON

Motor	gasolina 4T
Cilindrada	196 cc
Potencia	6,5 CV
Velocidades	3 adelante + 1 atrás
Carga máxima	300 kg
Caja	de acero, expandible
Largo 910-1040 mm Ancho 600-860 mm Alto 205 mm	
Descarga	basculante c/ pistón de gas
Freno	Sí (eléctrico)
Marcha atrás	Sí

PVP s/IVA **1.565€**
PVP c/IVA **1.894€**

D30MB



TRANSPORTES



Transporter MGM
MGM TRS340

Motor	Honda GX160
Cilindrada	163 cc
Potencia	4,8 CV
Velocidades	3 adelante + 1 atrás 1,15 / 2,20 / 2,80 Km/h adelante 0,90 Km/h atrás
Transmisión	Mecánica c/ control independiente de orugas
Carga máxima	350 kg
Caja	de acero, expandible Largo 970 mm Ancho 710 mm Alto 200 mm
Orugas (mm)	180 x 60 x 34
Superficie apoyo (mm)	180 x 650 por oruga
Basculación	manual
Peso	190 kg



PVP s/IVA 3.300€
PVP c/IVA 3.993€

MGM TRS440
Transporter MGM

PVP s/IVA 3.950€
PVP c/IVA 4.780€

Motor	Honda GX160
Cilindrada	163 cc
Potencia	4,8 CV
Velocidades	3 adelante + 1 atrás 1,15 / 2,20 / 2,80 Km/h adelante 0,90 Km/h atrás
Transmisión	Mecánica c/ control independiente de orugas
Carga máxima	450 kg
Caja	de acero, expandible Largo 970 mm Ancho 740 mm Alto 320 mm
Orugas (mm)	180 x 60 x 38
Superficie apoyo (mm)	180 x 720 por oruga
Peso	230 kg
Opciones	Sistema hidráulico de basculación

Transporter MGM
MGM TRS660

Motor	Honda GX160
Cilindrada	163 cc
Potencia	4,8 CV
Velocidades	4 adelante + 2 atrás 1,30 / 2,20 / 2,90 / 4,60 Km/h adelante 1,30 / 2,20 Km/h atrás
Transmisión	Mecánica c/ control independiente de orugas
Carga máxima	600 kg
Caja	de acero, expandible Largo 970 mm Ancho 740 mm Alto 320 mm
Orugas (mm)	180 x 72 x 34
Superficie apoyo (mm)	180 x 900 por oruga
Peso	280 kg
Opciones	Sistema hidráulico de basculación, cajón dumper, peana



PVP s/IVA 5.335€
PVP c/IVA 6.455€





R80-V



A10

A107L



KD186 FADE

MOTORES	R80-V	A107	A107L	KD186 FADE
Combustible	gasolina 4T	gasolina 4T	gasolina 4T	diésel
Cilindrada	80 cc	212 cc	212 cc	418 cc
Potencia	2.5 CV	7 CV	7 CV	12 CV
Arranque	manual	manual	manual	eléctrico
Filtro	seco	baño de aceite	baño de aceite	baño de aceite
Cigüeñal	Ø15 mm	cilíndrico	tipo Lombardini	tipo Lombardini
	Ø15.8 mm		L52mm	L52mm
			Ø20mm punta	Ø20mm punta
				Ø23mm base
Peso	10 kg	13 kg	13 kg	45 kg
PVP s/IVA	145 €	180 €	265 €	975 €
PVP c/IVA	175 €	218 €	321 €	1.180 €

MOTORES FANTON



MOTOBOMBAS

FANTON



PT733



PB825



PB807

MOTORES	PT733	PB825	PB807
Motor	gasolina 2T	gasolina 4T	gasolina 4T
Cilindrada	33 cc	80 cc	212 cc
Potencia	0.75 CV	2.5 CV	7 CV
Arranque	manual	manual	manual
Caudal	150 l/min	225 l/min	425 l/min
Ø manguera	1"	1.5"	2"
PVP s/IVA	180 €	195 €	275 €
PVP c/IVA	218 €	236 €	333 €

MOTOBOMBAS FANTON





Generador FANTON

SRGE4000

Motor	gasolina 4T
Cilindrada	223 cc
Arranque	manual
Voltaje	230 V
Frecuencia	50 Hz
Potencia	3.500 W
AVR	sí
Vol. combustible	17 litros
Peso	50 kg

PVP s/IVA **485€**

PVP c/IVA **587€**



SRGE8500E

Generador FANTON



Motor	gasolina 4T
Cilindrada	445 cc
Arranque	manual/eléctrico
Voltaje	230 V
Frecuencia	50 Hz
Potencia	7.500 W
AVR	sí
Vol. combustible	30 litros
Peso	96 kg

PVP s/IVA **995€**

PVP c/IVA **1.204€**



**GENERADORES
FANTON**





DE CADENAS



Modelo*	Ancho de trabajo	Espesor de chapa	Peso	TDF	No. de cadenas	PVP s/IVA	PVP c/IVA
F90	90 cm	4 mm	120 kg	c/ fusible	2	920 €	1.113 €
F100	100 cm	4 mm	135 kg			960 €	1.162 €
F110	110 cm	5 mm	150 kg			995 €	1.204 €
F120	120 cm	5 mm	180 kg			1.095 €	1.325 €
F130	130 cm	5 mm	230 kg			1.140 €	1.379 €
FAN140	140 cm	8 mm	420 kg	c/ embrague	4	1.775 €	2.148 €
FAN150	150 cm	8 mm	470 kg			1.895 €	2.293 €
FAN160	160 cm	8 mm	520 kg			1.995 €	2.414 €
FAN170	170 cm	8 mm	580 kg			2.195 €	2.656 €
FAN180	180 cm	8 mm	620 kg			2.245 €	2.716 €
FAN200	200 cm	8 mm	750 kg			2.590 €	3.134 €
Opción de carro hidráulico desplazable						690 €	835 €



SERIE G.US

SERIE M.SR



*Incluye transmisión



SERIE F.US A

DE MARTILLOS FIJAS



Modelo	Ancho de trabajo	Potencia tractor	Capó trasero	Ømáx. triturado	Ancho (mm)	No. correas	Rotor		Peso	PVP s/IVA	PVP c/IVA
							Øext (mm)	No. martillos			
G.US105	105 cm	20-40 CV	flexible	30 mm	1180	2	270	14	170 kg	1.350 €	1.634 €
G.US125	125 cm				18			197 kg	1.400 €	1.694 €	
F.US145A	145 cm	40-70 CV	rígido practicable	50 mm	1620	3	340	18	351 kg	2.175 €	2.632 €
F.US165A	165 cm				20			365 kg	2.260 €	2.735 €	
F.US185A	185 cm				22			399 kg	2.340 €	2.831 €	
M.SR200	200 cm				35-85 CV			26	524 kg	2.995 €	3.624 €

Incluyen transmisión cardan

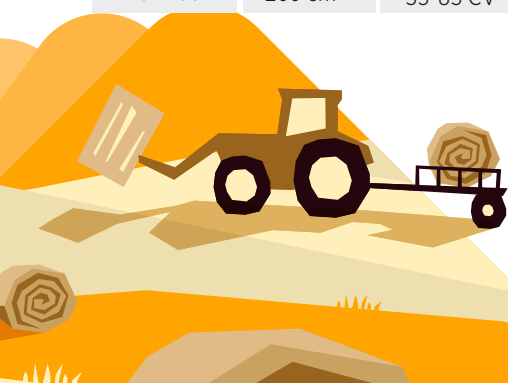

DESBROZADORAS DE TRACTOR





SERIE G.US H



SERIE F.US HA

DE MARTILLOS HIDRAULICAS



Rotor

Modelo	Ancho de trabajo	Potencia tractor	Capó trasero	Ø máx. triturado	Ancho (mm)	No. correas	Ø ext (mm)	No. martillos	Peso	PVP s/IVA	PVP c/IVA
G.US125H	125 cm	20-40 CV	flexible	30 mm	1380	2	270	18	225 kg	1.625€	1.966€
F.US145HA	145 cm	20-40 CV	rígido	50 mm	1620	3	340	18	354 kg	2.470€	2.989€
F.US165HA	165 cm	40-70 CV	practicable	50 mm	1820	3	340	20	374 kg	2.550€	3.086€
F.US185HA	185 cm	40-70 CV		50 mm	2020	3	340	22	414 kg	2.640€	3.194€

Incluyen transmisión cardan



SERIE G.OS

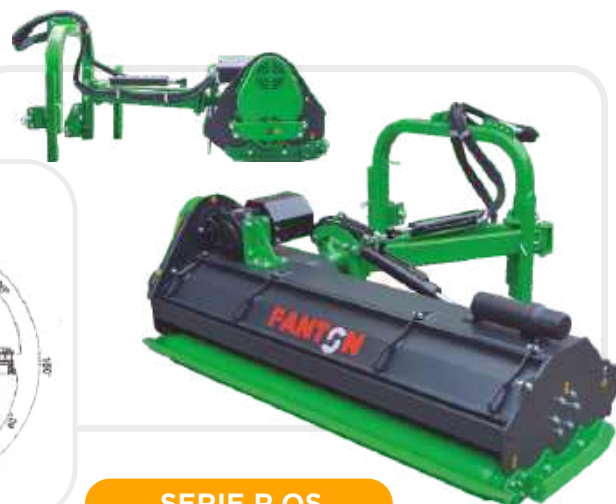
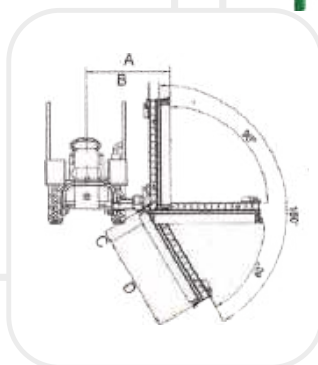

SERIE R.OS

DE MARTILLOS MULTIFUNCIONALES



Rotor

Modelo	Ancho de trabajo	Potencia tractor	Capó trasero	Ø máx. triturado	Ancho (mm)	No. correas	Ø ext (mm)	No. martillos	Peso	PVP s/IVA	PVP c/IVA
G.OS125	125 cm	25-45 CV	flexible	30 mm	1390	2	270	18	285 kg	2.250€	2.723€
G.OS145	145 cm	25-45 CV		30 mm	1590	2	270	20	309 kg	2.295€	2.777€
R.OS165	165 cm	45-70 CV	rígido	50 mm	1820	3	340	20	419 kg	3.050€	3.691€
R.OS185	185 cm	45-70 CV	practicable	50 mm	2020	3	340	22	437 kg	3.125€	3.781€

Incluyen transmisión cardan



DESBROZADORAS DE TRACTOR

SERIE 290

2T1000F

2T1200F
DE MARTILLOS SERIE 290 FIJAS
Rotor triturado

Modelo	Ancho de trabajo	Potencia tractor	No. correas	Øext (mm)	No. martillos	Espesor chapa	Peso	PVP s/IVA	PVP c/IVA
2T1000F	100 cm	20-50 CV	2	290	14	3 mm	113 Kg	1.940€	2.347€
2T1200F	120 cm				18		125 Kg	1.980€	2.396€

No incluyen transmisión cardan

SERIE 400

DE MARTILLOS SERIE 400 FIJAS
Rotor triturado

Modelo	Ancho de trabajo	Potencia tractor	No. correas	Øext (mm)	No. martillos	Espesor chapa	Peso	PVP s/IVA	PVP c/IVA
4T1400F	140 cm	35-50 CV	3	400	20	3 mm	400 kg	3.610€	4.368€
4T1600F	160 cm				22		435 kg	3.765€	4.556€
4T1800F	180 cm	50-70 CV	4		26	4 mm	482 kg	3.955€	4.786€
4T2000F	200 cm	60-80 CV			30		505 kg	4.145€	5.015€

No incluyen transmisión cardan



SERIE 400ID



DE MARTILLOS SERIE 400ID HIDRÁULICAS

Rotor triturado

Modelo	Ancho de trabajo	Potencia tractor	No. correas	Øext (mm)	No. martillos	Espesor chapa	Peso	PVP s/IVA	PVP c/IVA
4T1400ID	140 cm	35-50 CV	3	400	20	4+4 mm	455 kg	4.060€	4.913€
4T1600ID	160 cm	40-70 CV			22		473 kg	4.240€	5.130€
4T1800ID	180 cm	50-80 CV	4		26	500 kg	4.325€	5.233€	

No incluyen transmisión cardan

SERIE JIRAFA

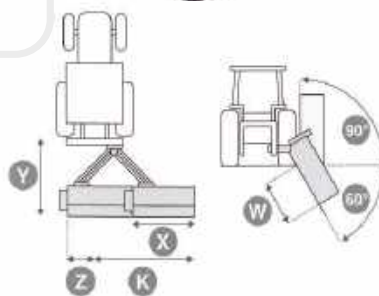

	X	Y	Z	K	W
1400	1325	1850	800	2580	1200
1600	1505	1850	800	2780	1400
1800	1645	1850	800	2980	1800

DE MARTILLOS SERIE MULTIFUNCCIONAL

Rotor triturado

Modelo	Ancho de trabajo	Potencia tractor	No. correas	Øext (mm)	No. martillos	Espesor chapa	Peso	PVP s/IVA	PVP c/IVA
G2T1200F	120 cm	20-35 CV	2	290	18	2,5 mm	205 kg	3.800€	4.598€
G2T1400F	140 cm				22		217 kg	3.895€	4.713€
G4T1600F	160 cm	50-80 CV	3	400	22	4+4 mm	638 kg	6.480€	7.841€
G4T1800F	180 cm	70-100 CV	4		26		670 kg	6.710€	8.120€
G4T2000F	200 cm	90-120 CV			30	710 kg	6.895€	8.343€	

No incluyen transmisión cardan



TCP

TCR

THR

TL

Modelo	Descripción	PVP s/IVA	PVP c/IVA
TL	Pastor eléctrico de baja potencia para animales de compañía c/ conexión a la red. Incl. Blíster 10 aisladores.	120 €	145 €
THR	Pastor eléctrico con conexión a red eléctrica 220V. Perímetro máximo 8 km.	170 €	206 €
TCR	Pastor eléctrico recargable 220V. Duración carga 300 h a potencia baja, 150 h a potencia alta. Perímetro máximo 40 km	255 €	309 €
TCP	Pastor eléctrico para pila de larga duración (no incluida). Perímetro máximo 6 km.	160 €	194 €
P-11	Poste portátil en plástico para 7 hilos/6 cintas	3,10 €	3,75 €
A-10	Rollo 200 m de hilo perimetral de alta calidad	12,00 €	14,50 €
A-15	Rollo 200 m de cinta perimetral de alta calidad	23,00 €	27,83 €
A-4	Aislador clásico de 38 mm, sujeción por clavo o tornillo	0,20 €	0,24 €
A-2	Aislador para madera de 5 mm x 35 mm de largo	0,42 €	0,51 €
A-26	Pila estándar de alta calidad 9V, 55 Ah	35,00 €	42,35 €





Vareadoras FANTON

Cabezal Zeus FZ100

Cantidad	10 uds
Material	carbono
Longitud	300 mm
Movimiento	lateral
	900-1200 ciclos/min (según motor)
Ancho de trabajo	600 mm
	7 estrías
	9 estrías
Estriados compatibles	cuadrado 5.4 mm
	cuadrado 6 mm
Peso	1,6 kg

PVP s/IVA **375€**

PVP c/IVA **454€**

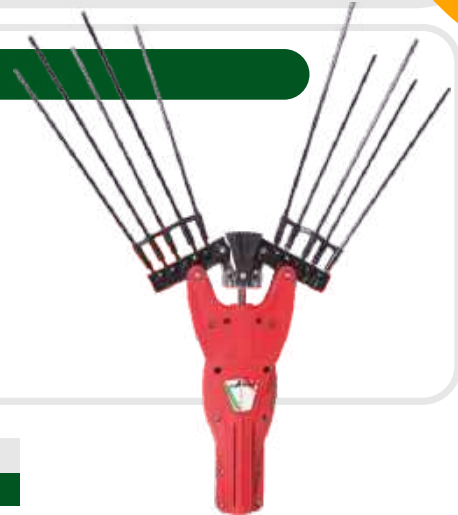

Vareadoras FANTON

Zeus F200f

Zeus F200t

Zeus F200f fija

Zeus F200t telescópica



Motor	eléctrico 12 V	eléctrico 12 V
Potencia	270 W	270 W
Alimentación	batería plomo 12 V (no incl.)	batería plomo 12 V (no incl.)
Cable alimentación	15 m (incl.)	15 m (incl.)
Barra		
Material		aluminio
Empuñadura	ergonómica c/ interruptor	ergonómica c/ interruptor
Longitud		hasta 2,3 m telescópica (3,3 m c/ extensión)
Varillas		
Cantidad	10 uds	10 uds
Material	carbono	carbono
Longitud	280 mm	280 mm
Movimiento	lateral 1600 ciclos/min	lateral 1600 ciclos/min
Peso	2,3 kg	2,4 kg
PVP s/IVA	440€	550€
PVP c/IVA	532€	666€



CADENA DE MOTOSIERRA EN ROLLO

Paso	Galga	Tipo	Longitud	PVP s/IVA	PVP c/IVA
1/4"	.043" / .050"	Semichisel	25 pies/600 eslabones	142 €	172 €
3/8" Bajo Perfil	.043" / .050"	Semichisel	25 pies/410 eslabones	70 €	85 €
3/8" Bajo Perfil	.050"	Semichisel	100 pies/1.640 eslabones	240 €	290 €
0.325"	.050" / .058" / .063"	Semichisel	100 pies/1.740 eslabones	260 €	315 €
0.325"	.050" / .058" / .063"	Chisel	100 pies/1.740 eslabones	295 €	357 €
3/8"	.050" / .058" / .063"	Semichisel	100 pies/1.640 eslabones	260 €	315 €
3/8"	.050" / .058"	Chisel	100 pies/1.640 eslabones	295 €	357 €
0.404"	.063" / .080"	Semichisel	100 pies/1.480 eslabones	320 €	387 €

CADENA DE MOTOSIERRA CORTADA

Paso	Galga	Longitud (eslabones)	PVP s/IVA	PVP c/IVA
3/8" Bajo Perfil	.043" / .050"	40	9,50 €	11,50 €
3/8" Bajo Perfil	.043" / .050"	44	9,90 €	11,98 €
3/8" Bajo Perfil	.043" / .050"	46	10,10 €	12,22 €
3/8" Bajo Perfil	.043" / .050"	48	10,30 €	12,46 €
3/8" Bajo Perfil	.043" / .050"	50	10,50 €	12,71 €
3/8" Bajo Perfil	.043" / .050"	52	10,60 €	12,83 €
3/8" Bajo Perfil	.043" / .050"	56	10,80 €	13,07 €
3/8" Bajo Perfil	.043" / .050"	57	11,00 €	13,31 €
3/8" Bajo Perfil	.043" / .050"	60	11,50 €	13,92 €
3/8"	.050" / .058" / .063"	58	10,50 €	12,71 €
3/8"	.050" / .058" / .063"	60	10,80 €	13,07 €
3/8"	.050" / .058" / .063"	64	11,50 €	13,92 €
3/8"	.050" / .058" / .063"	66	11,90 €	14,40 €
3/8"	.050" / .058" / .063"	68	12,25 €	14,82 €
3/8"	.050" / .058" / .063"	69	12,50 €	15,13 €
3/8"	.050" / .058" / .063"	72	12,95 €	15,67 €
0.325"	.050" / .058" / .063"	62	11,15 €	13,49 €
0.325"	.050" / .058" / .063"	64	11,50 €	13,92 €
0.325"	.050" / .058" / .063"	66	11,90 €	14,40 €
0.325"	.050" / .058" / .063"	68	12,25 €	14,82 €
0.325"	.050" / .058" / .063"	70	12,60 €	15,25 €
0.325"	.050" / .058" / .063"	72	12,95 €	15,67 €
0.325"	.050" / .058" / .063"	74	13,30 €	16,09 €
0.325"	.050" / .058" / .063"	76	13,70 €	16,58 €
0.325"	.050" / .058" / .063"	78	14,05 €	17,00 €
Medidas distintas a las anteriores, precio por eslabon adicional			0,20 €	0,24 €















ESPADAS DE MOTOSIERRA



Longitud	Paso	Galga	PVP s/IVA	PVP c/IVA
10" / 25 cm	3/8" Bajo Perfil	.050"	16,0 €	19,36 €
12" / 30 cm	3/8" Bajo Perfil	.050"	17,0 €	20,57 €
14" / 35 cm	3/8" Bajo Perfil	.050"	19,0 €	22,99 €
15" / 38 cm	0.325"	.058"	20,5 €	24,81 €
16" / 40 cm	3/8" Bajo Perfil	.050"	20,5 €	24,81 €
16" / 40 cm	0.325"	.058"	21,0 €	25,41 €
17" / 43 cm	3/8"	.058"	21,0 €	25,41 €
18" / 45 cm	3/8"	.058"	21,5 €	26,02 €
18" / 45 cm	0.325"	.058"	21,5 €	26,02 €
18" / 45 cm	0.325"	.063"	21,5 €	26,02 €
20" / 50 cm	3/8"	.058"	28,0 €	33,88 €

Artículo	Comentario	PVP s/IVA	PVP c/IVA
----------	------------	-----------	-----------

	Aceite engrase motosierra	Garrafa 5L	15,40 €	18,63 €
	Caballote	30	70,00 €	85,00 €
	Cortadora de cadena		63,00 €	76,23 €
	Remachadora de cadena		63,00 €	76,23 €
	Afiladora de cadena	Próximamente	115,00 €	139,15 €
	Piedra afilado hobby	Øext 105mm, Øint 22mm, espesor 3,2/4,7mm	11,75 €	14,22 €
	Piedra afilado profesional	Øext 145mm, Øint 22mm, espesor 3,2/4,7 mm	14,00 €	16,94 €
	Mango Bahco para lima	Ø3.2 mm Ø4.0 mm Ø4.8 mm Ø5.2 mm Ø5.5 mm	2,50 €	3,03 €
	Lima redonda Bahco	Ø4mm, Ø4,8mm, Ø5,2mm, Ø5,8mm	1,75 €	2,12 €
	Lima plana Bahco	Long. 150mm, ancho 16mm, espesor 2,5mm	3,55 €	4,30 €



DISCOS DESBROCE OEM

	Artículo	Diametro	Espesor	Agujero	PVP s/IVA	PVP c/IVA
	2P Recto Mulching	305 mm	3 mm	20/25.4 mm	10,50 €	12,71 €
		305 mm	4 mm		11,50 €	13,92 €
	2P Curvo Mulching	320 mm	3 mm	20/25.4 mm	12,50 €	15,13 €
		320 mm	4 mm		12,95 €	15,67 €
	2P Curvo Mulching	280 mm	3 mm	25.4 mm	11,75 €	14,22 €
	2P Recto	350 mm	3 mm	20/25.4 mm	11,00 €	13,31 €
		350 mm	4 mm		14,45 €	17,48 €
	3P Plano	300 mm	3 mm	20/25.4 mm	13,25 €	16,03 €
			4 mm		15,50 €	18,76 €
		350 mm	4 mm		17,50 €	21,18 €
	3P Mulching	300 mm	3 mm	25.4 mm	22,00 €	26,62 €
	3P Curvo Mulching	300 mm	4 mm	20 mm	25,00 €	30,25 €

Nota: Por la compra de 12 discos de cualquier referencia se sirve una unidad del disco de menor precio sin cargo.

DISCOS DE WIDEA

	Artículo	Antirrebote	Diametro	Espesor	Agujero	PVP s/IVA	PVP c/IVA
	FANTON 20P	curvo	255 mm	1,8 mm	20/25.4 mm	29,00 €	35,09 €
	RATIOPARTS 20P	recto	250 mm	1,8 mm	20/25.4 mm	27,00 €	32,67 €
	AGROSA 20P	recto	250 mm	1,8 mm	20/25.4 mm	18,00 €	21,78 €
	KINGARDEN 20P	curvo	255 mm	1,8 mm	20/25.4 mm	12,00 €	14,52 €
	KINGARDEN 36P	N/A	250 mm	1,4 mm	20/25.4 mm	9,50 €	11,50 €





HILO DE NYLON		Presentación	Longitud	Ø	Uds/caja	PVP s/IVA	PVP c/IVA
	Redondo	Blister	15 m	1.3 mm	40	1,50 €	1,82 €
				2.0 mm		1,95 €	2,36 €
				2.4 mm		2,50 €	3,03 €
				3.0 mm		3,50 €	4,24 €
				3.3 mm		3,75 €	4,54 €
		Rollo	87	2.4 mm	14	9,75 €	11,80 €
			56	3.0 mm		9,75 €	11,80 €
			46	3.3 mm		9,75 €	11,80 €
		Bobina	168	3.0 mm	14	31,00 €	37,51 €
139	3.3 mm		31,00 €	37,51 €			
	Cuadrado	Blister	15	3.0 mm	40	3,50 €	4,24 €
				4.0 mm		5,65 €	6,84 €
		Rollo	51	3.0 mm	20	9,75 €	11,80 €
			42	3.3 mm		9,75 €	11,80 €
			29	4.0 mm		9,75 €	11,80 €
		Tubo 50 u.	0,35	3.0 mm	14	8,30 €	10,04 €
			Helicoidal	Rollo	56	3.0 mm	40
46	3.3 mm				12,50 €	15,13 €	
31	4.0 mm				12,50 €	15,13 €	
Bobina	168			3.0 mm	14	39,25 €	47,49 €
	139			3.3 mm		39,25 €	47,49 €
	94			4.0 mm		39,25 €	47,49 €
	Tiburón	Rollo	47	3.0 mm	14	14,50 €	17,55 €
			38	3.3 mm		14,50 €	17,55 €
			26	4.0 mm		14,50 €	17,55 €
			21	4.5 mm		14,50 €	17,55 €
		Bobina	79	4.0 mm	14	34,50 €	41,75 €
			Aluminio	Rollo	56	3.0 mm	14
46	3.3 mm				13,25 €	16,03 €	

Blister: por compra de caja completa, 6 uds. de regalo

Rollo/ Bobina: por compra de caja completa, 2 uds. de regalo



Blister



Rollo



Bobina

40

GRASA DE CABEZAL

	Artículo	Características	PVP s/IVA	PVP c/IVA
	Grasa para cabezal	125 c.c.	4,35 €	5,26 €
	Grasa para cabezal	200 c.c.	5,50 €	6,66 €















COMPONENTES DE DESBROZADOR

	Artículo	Características	PVP s/IVA	PVP c/IVA
	Motor 2T desbrozador 43 c.c.	Potencia 1.7 CV	125,00 €	151,25 €
	Motor 2T desbrozador 52 c.c.	Potencia 2 CV	145,00 €	175,45 €
	Barra completa FANTON	Ø28 mm manillar doble disco no incluido	125,00 €	151,25 €
	Barra completa HOSHI	Ø28 mm manillar doble disco no incluido	193,00 €	233,53 €
	Barra completa ASUKA AS450/W	Ø28 mm manillar doble disco no incluido	236,00 €	285,56 €
	Barra completa ASUKA VF500 antivibración	Ø28 mm manillar doble disco no incluido	250,00 €	302,50 €
	Barra de mochila ASUKA FLEX	Ø26 mm disco no incluido	365,00 €	441,65 €
	Cabezal hilo nylon F202BVP	Universal, carga fácil, Tap&Go	11,00 €	13,31 €
	Cabezal hilo nylon F202BVR	Carga fácil, Tap&Go 4 roscas: M12 x 1.5/ M12 x 1.75 M8 x 1.25 / M10 x 1.25	13,00 €	15,73 €
	Cabezal de aluminio Arizona	c/ tornillo lateral	12,00 €	14,52 €
	Disco de alambre	Ø 200 mm Ø agujero 25.4 mm	22,00 €	26,62 €

**ACCESORIOS
DESBROZADORAS**



RECAMBIO DE DESBROZADOR

Artículo	Características	PVP s/IVA	PVP c/IVA
 Soporte de barra	Ø26mm / Ø28mm, incl. campana embrague	33,00 €	39,93 €
 Campana de embrague	9 estrías / Øint 77,75mm Øeje 15mm / altura 20mm	24,50 €	29,65 €
 Cabezal compatible	7 estrías - Ø24mm, Ø26mm, Ø28mm 9 estrías - Ø26mm, Ø28mm, Ø30mm 10 estrías - Ø26mm, Ø28mm 10 estrías ALPINA - Ø28mm 11 estrías - Ø28mm 6mm - Ø26mm, Ø28mm	58,00 €	70,18 €
 Kit embrague	Compatible Kawasaki TD, TH, TJ	15,00 €	18,15 €
 Soporte de manillar	Ø26 mm, Ø28 mm	14,50 €	17,55 €
 Mando de gas	Manillar Ø19mm	26,00 €	31,46 €
 Soporte de correaje	Ø26 mm, Ø28 mm	9,75 €	11,80 €
 Tubo barra aluminio	Long. 150 cm / Varilla de Ø8mm Ø24mm, Ø26 mm, Ø28 mm	46,00 €	55,66 €
 Eje de transmisión	Long. 1540 mm / Ø 8 mm 9 estrías	29,85 €	36,12 €
 Eje flexible desbrozador mochila 890 mm	Long. 890 mm / 6.8 mm	16,25 €	19,66 €
 Eje flexible desbrozador mochila 930 mm	Long. 930 mm/ 6.8 mm	16,75 €	20,27 €
 Protector de cabezal RD100	Ø26 mm, Ø28 mm con pletina anti-giro	15,50 €	18,76 €
 Cazoleta protectora tornillo	Agujero Ø8mm, Ø10mm, Ø12 mm	3,00 €	3,63 €
 Arandela inferior	6 estrías	10,50 €	12,71 €
 Arandela guía	6 estrías	11,50 €	13,92 €

**ACCESORIOS
DESBROZADORAS**



40

ELEMENTOS DE PROTECCIÓN

Artículo	Características	PVP s/IVA	PVP c/IVA
 Pantalla protección facial SPO101	Regulable, malla aluminio	8,50 €	10,29 €
 Pantalla protección c/ auriculares SPO101A	Regulable, malla aluminio, c/ auriculares	16,50 €	19,97 €
 Pantalla protección facial SPO102	C/ banda elástica, malla aluminio	5,50 €	6,66 €
 Pantalla protección facial SPO103	Regulable, PVC	7,50 €	9,08 €
 Auriculares 8R		6,50 €	7,87 €
 Corraje estándar	Talla única ajustable	14,50 €	17,55 €
 Corraje lúxury	Talla única ajustable	34,00 €	41,14 €
 Juego de polainas	Talla única ajustable	18,00 €	21,78 €













OTROS ACCESORIOS
BUJÍAS

Artículo	Características	PVP s/IVA	PVP c/IVA
 Bujía FANTON FJ7Y	Para motosierra y desbrozador (motores 2T)	1,80 €	2,18 €
 Bujía FANTON F82C	Cuello corto tipo "moto" para motores 4T	1,95 €	2,36 €
 Bujía FANTON F82L	Cuello largo para motores 4T FANTON y HONDA	2,15 €	2,60 €
 Bujía CHAMPION CJ7Y	Para motosierra y desbrozador (motores 2T), cajas de 10 uds	2,80 €	3,39 €





RECAMBIOS

Artículo	Características	PVP s/IVA	PVP c/IVA
 Filtro de gasolina aluminio	Long. 28 mm / Ø filtro 20 mm / Ø tubo 5,4 mm	1,98 €	2,40 €
 Filtro de gasolina plástico	Long. 28 mm / Ø filtro 20 mm / Ø tubo 4 mm	1,98 €	2,40 €
 Filtro de aire papel c. Briggs	Comp. HONDA GC & GCV, B&S Quantum 3-5HP Dim. L132mm x An115mm x Al22mm	3,25 €	3,93 €
 Capuchón de bujía c/ muelle	Ø cable 5 mm	1,35 €	1,63 €
 Capuchón de bujía c/ rosca	Ø cable 5 mm	2,10 €	2,54 €
 Pastilla electrónica	1 ó 2 salidas	12,00 €	14,52 €
 Grifo gasolina generador	M10x1.25 / Øtubo 7 mm	13,75 €	16,64 €
 Grifo gasolina	M16x1.5 / Øtubo 7 mm	14,33 €	17,34 €
 Tubo gasolina transparente (rollos 5 m)	Ø int 2.8 mm	18,00 €	21,78 €
	Ø int 3.2 mm	23,00 €	27,83 €
	Ø int 4.8 mm	30,00 €	36,30 €
	Ø int 6.3 mm	35,00 €	42,35 €
 Cordel de arranque(rollos 100 m)	Ø 3.0 mm	24,00 €	29,04 €
	Ø 3.5 mm	33,00 €	39,93 €
	Ø 4.0 mm	36,50 €	44,17 €
	Ø 4.5 mm	40,00 €	48,40 €
	Ø 5.0 mm	45,00 €	54,45 €
 Tapa puesta en marcha	Comp. HONDA GCV	25,00 €	30,25 €
 Depósito gasolina	omp. HONDA GX160/200	25,00 €	30,25 €

ACCESORIOS
DESBROZADORAS



LUBRICANTES

Artículo	Características	PVP s/IVA	PVP c/IVA
	Aceite de engrase de cadena	Garrafa de 5L	15,40 € 18,63 €
	Grasa para cabezal	125 c.c.	4,35 € 5,26 €
	Grasa para cabezal	200 c.c.	5,50 € 6,66 €
	Aceite sintético 2 tiempos	Bote de 1 litro con dosificador / JASO FD API TC/TSC-1, TSC-2, TSC-3	10,50 € 12,70 €
	Aceite sintético 2 tiempos	Bote de 125 ml / JASO FD API TC/TSC-1, TSC-2, TSC-3	1,90 € 2,30 €
	Aceite SAE30 4T	Bote de 0,6 litros / API CF/SF	6,75 € 8,17 €



CUCHILLAS CORTACÉSPED

Artículo	Características	Ancho de corte L (cm)	PVP s/IVA	PVP c/IVA
Cuchillas universales para cortacésped Aletadas Planas	<p>ZB - 25.4 mm AL - 38 mm x 9.5 mm AB - 76 mm Arandelas reductoras incluidas: Ø9.5 mm Ø12.7 mm Ø14.2 mm Ø15.8 mm Ø19.05 mm</p>	38	16,00 €	19,36 €
		40	18,00 €	21,78 €
		43	18,60 €	22,51 €
		45	19,20 €	23,23 €
		48	20,00 €	24,20 €
		50	21,70 €	26,26 €
		53	24,00 €	29,04 €

CUCHILLA UNIVERSAL CORTACÉSPED



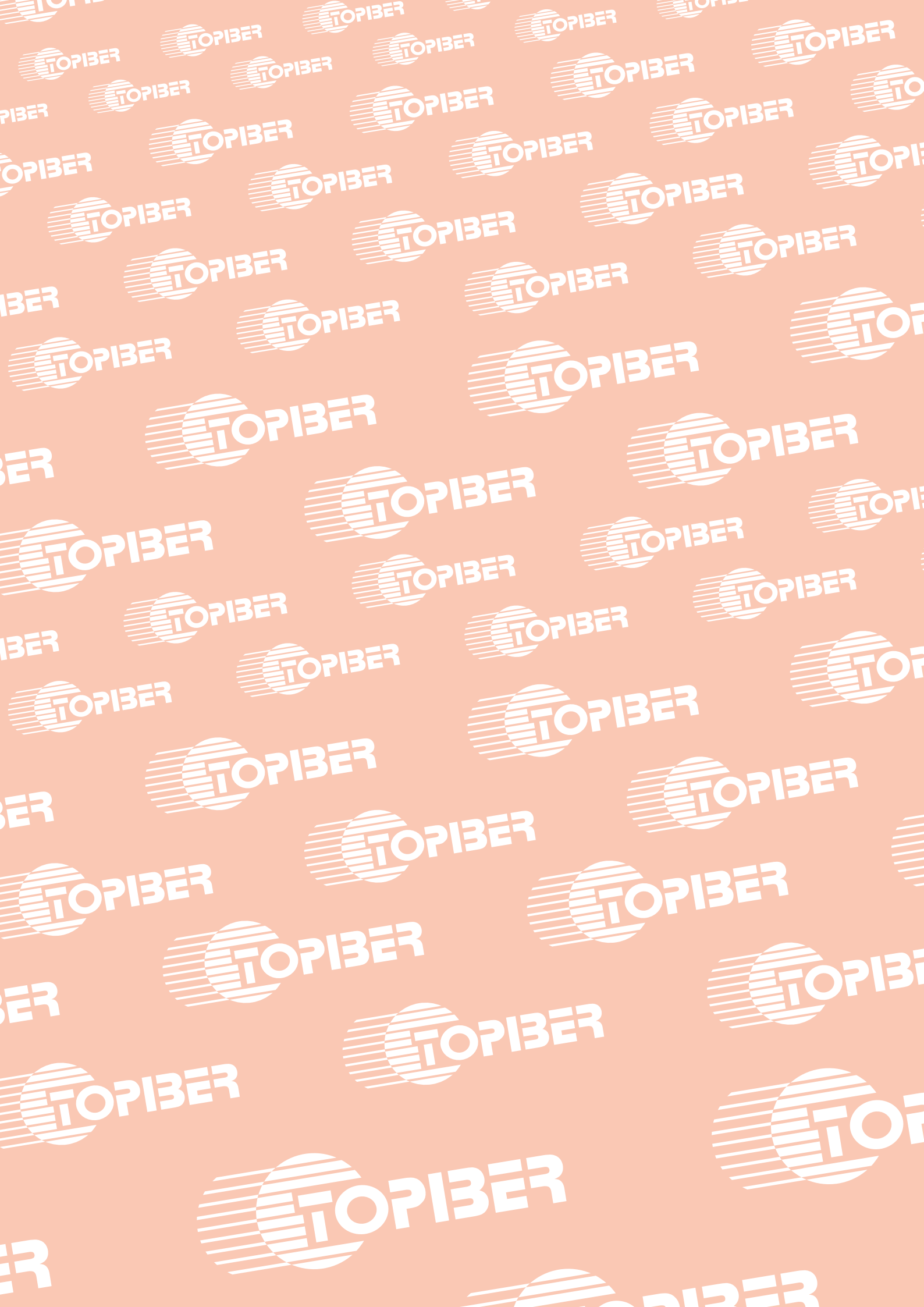



Pol. As Covas 49
Vilanovaña 36616
Meis Pontevedra
www.topiber.com